

SYNERGY3D

GEOTHERMAL HEAT PUMP + HYDRONIC

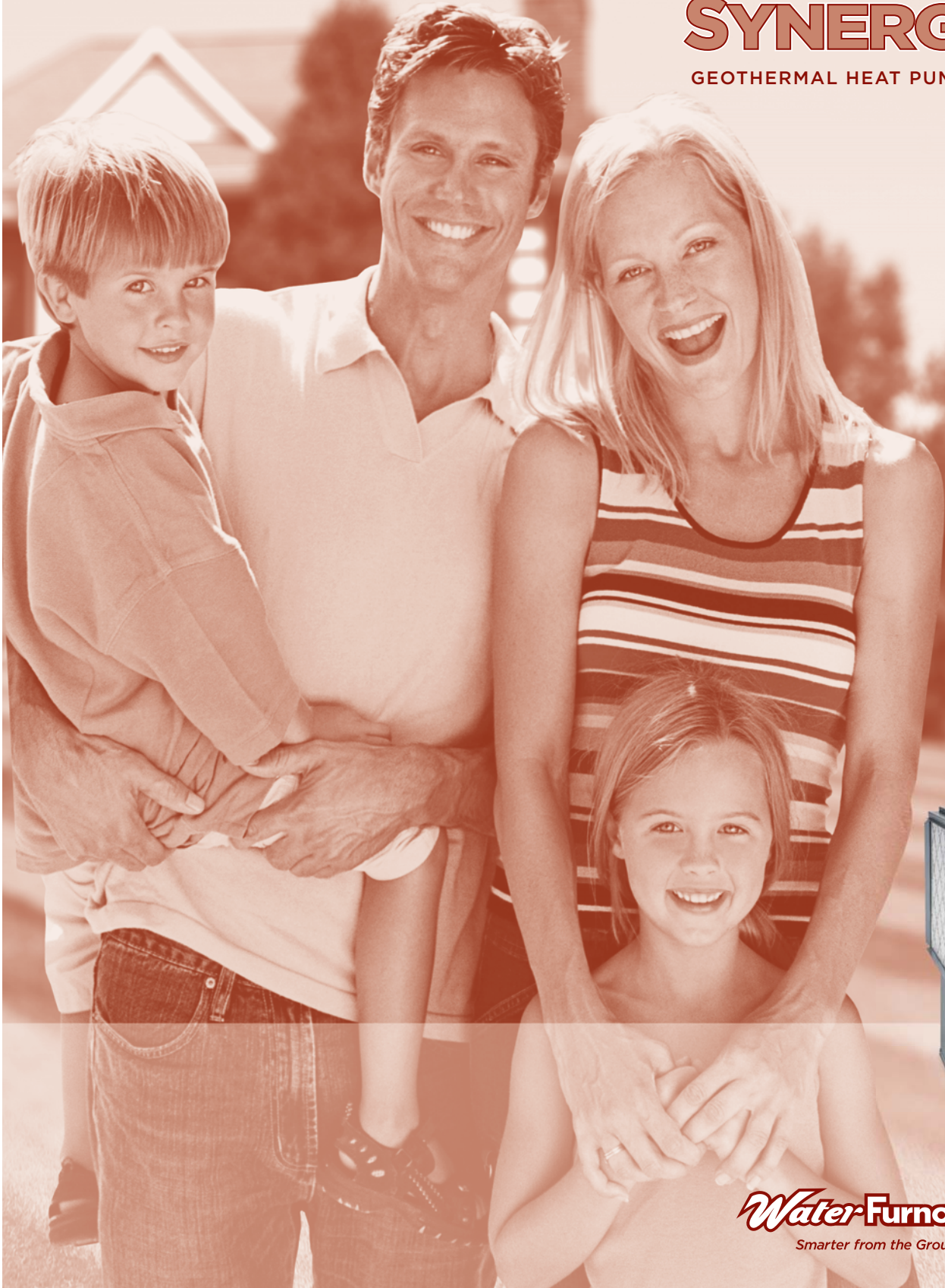

WaterFurnace
Smarter from the Ground Up™



Table of Contents

The Synergy3D	4
Model Nomenclature	5
AHRI/ISO 13256-1 Performance Ratings	6
Synergy3D Design Features	8
Microprocessor Control	11
Operation Logic	15
Water Quality	16
Application Information	17
Dimensional Data	19
Physical Data	21
Auxiliary Heat	22
Electrical Data	23
Blower Performance Data	24
Reference Calculations	25
Legend and Notes	25
Operating Limits	26
Antifreeze Corrections	27
Correction Factor Tables	28
Pressure Drop	29
Performance Data	30
Wiring Schematics	42
Engineering Guide Specifications	46
Revision Guide	50

SYNERGY3D



With the WaterFurnace Synergy3D Series, you'll receive superior comfort, incredible performance and energy savings. Integrating the comfort of a radiant floor heating system with the advantages of geothermal technology, the Synergy3D provides forced air heating and cooling to ducted zones while simultaneously providing hot water to radiant floor zones. The Synergy3D is the geothermal equivalent of a boiler, furnace and air conditioner— a three-in-one unit.

The Synergy3D line is available in four dual capacity sizes (3 to 6 tons) with Copeland Scroll UltraTech™ compressors.

The Synergy3D utilizes ozone-safe R-410A refrigerant to meet the most stringent EPA requirements. Coated air coils add durability and longer life. Variable speed ECM blowers are used to increase comfort and efficiency. A sophisticated microprocessor control sequences all components during operation for optimum performance, and provides easy-to-use troubleshooting features with fault lights and on-board diagnostics. The hinged, swing-out control box improves serviceability. Unit configurations include vertical top and rear discharge (left or right return). Heavy-gauge metal cabinets are fully insulated and coated with an attractive and durable paint for long lasting protection. The cabinet's rounded front corners, red wave styling element and gold nameplates add a touch of elegance to the unit.

Synergy3D products are performance-certified to AHRI ISO 13256-1 standards, ETL listed, ENERGY STAR® qualified, and tested in an ISO 17025 accredited testing lab.

As a leader in the industry, WaterFurnace is dedicated to innovation, quality and customer satisfaction. In fact, every unit built is exposed to a wide range of quality control procedures throughout the assembly process and is then subjected to a rigorous battery of computerized run tests to certify that it meets or exceeds performance standards for efficiency and safety, and will perform flawlessly at startup. As further affirmation of our quality standards, each unit carries our exclusive Quality Assurance emblem, signed by the final test technician.



WaterFurnace International's corporate headquarters and manufacturing facility is located in Fort Wayne, IN. A scenic three-acre pond located in front of the building serves as our geothermal heating and cooling source to comfort-condition our 110,000 square feet of manufacturing and office space. As a pioneer, and now a leader in the industry, the team of WaterFurnace engineers, customer support staff and skilled assembly technicians is dedicated to providing the finest comfort systems available.

By choosing or specifying WaterFurnace products, you can be assured that your customer is investing in the ultimate comfort system and peace of mind for many years to come.

Model Nomenclature

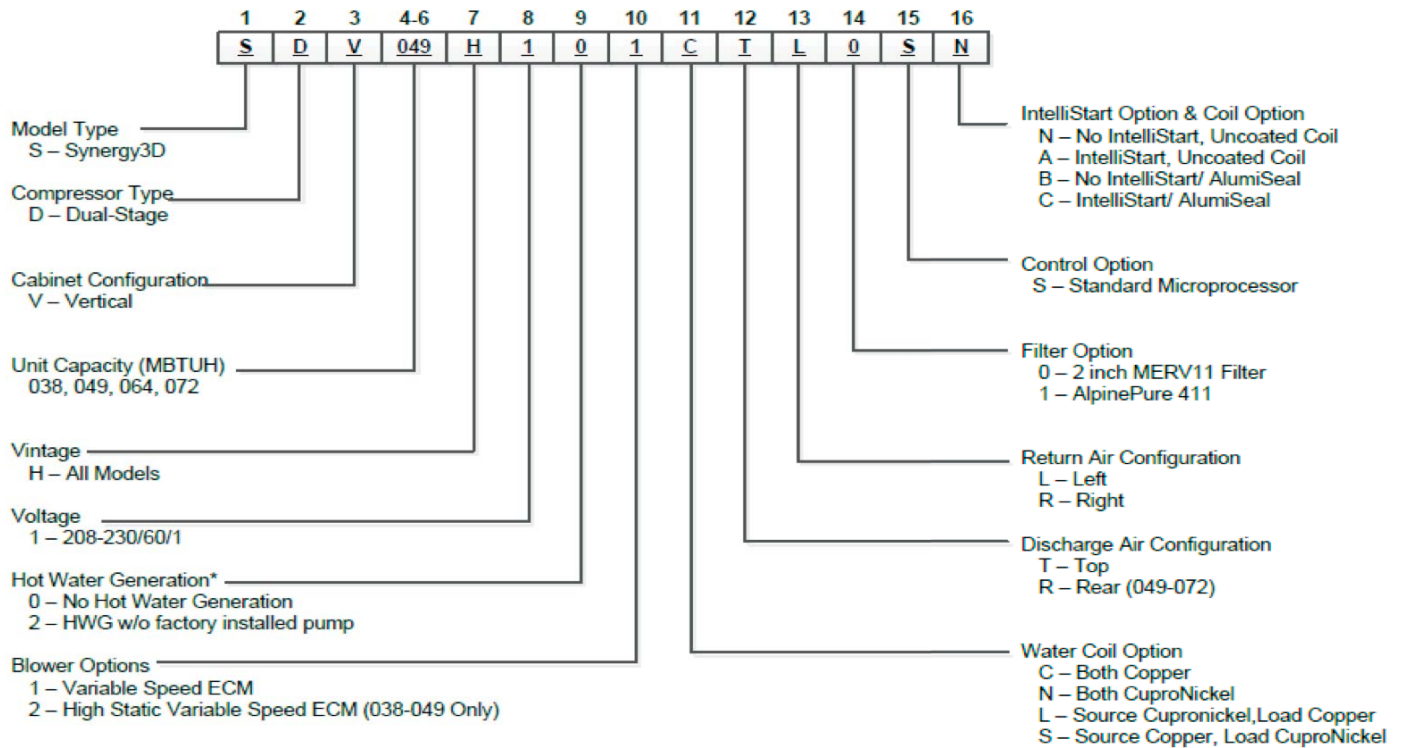

Notes:
*The factory installed Hot Water option (hot water generator) does not include a factory mounted circulating pump or temperature control. Kit DPKS (ordered separately) includes field installed circulator, hot water tank adaptor, temperature limit and installation instructions.

Rev.: 2/8/2017

AHRI/ISO 13256-1 Performance Ratings

ECM Motor

AHRI/ASHRAE/ISO 13256-1

English (IP) Units

Model	Capacity Modulation	Flow Rate		Ground Water Heat Pump				Ground Loop Heat Pump			
				Cooling EWT 59°F		Heating EWT 50°F		Full Load 77°F Part Load 68°F		Full Load 32°F Part Load 41°F	
		gpm	cfm	Capacity Btuh	EER Btuh/W	Capacity Btuh	COP	Capacity Btuh	EER Btuh/W	Capacity Btuh	COP
038	Full	9.0	1200	38,200	23.8	33,200	4.5	36,000	18.7	27,400	3.9
	Part	8.0	1000	28,600	30.6	23,700	4.6	27,000	24.9	21,500	4.2
049	Full	12.0	1500	50,200	23.1	46,900	4.5	47,700	18.2	38,000	3.8
	Part	11.0	1300	38,400	30.6	33,900	4.7	37,500	25.7	30,300	4.2
064	Full	16.0	1800	63,900	21.0	58,600	4.5	58,300	16.2	46,600	3.8
	Part	14.0	1500	47,800	27.2	41,500	4.7	45,100	22.6	36,900	4.2
072	Full	18.0	2000	73,400	20.3	69,000	4.3	68,500	16.1	54,500	3.7
	Part	16.0	1500	56,600	25.2	51,700	4.3	53,700	21.0	46,100	4.0

Energy Star Tier 3 affectivity date January 1, 2012

1/27/2017

Cooling capacities based upon 80.6°F DB, 66.2°F WB entering air temperature

Heating capacities based upon 68°F DB, 59°F WB entering air temperature

All ratings based upon 208V operation

ENERGY STAR Compliance Table

Model	Tier 3	
	Ground Water	Ground Loop
038	Yes	Yes
049	Yes	Yes
064	Yes	Yes
072	Yes	Yes

09/23/13

ENERGY STAR Rating Criteria

In order for water-source heat pumps to be ENERGY STAR rated they must meet or exceed the minimum efficiency requirements listed below.

Tier 3: 1/1/2012 - No Effective End Date Published

	EER	COP
Water-to-Air		
Ground Loop	17.1	3.6
Ground Water	21.1	4.1
Water-to-Water		
Ground Loop	16.1	3.1
Ground Water	20.1	3.5



AHRI/ISO 13256-1 Performance Ratings cont.

The performance standard AHRI/ASHRAE/ISO 13256-1 became effective January 1, 2000 and replaces ARI Standards 320, 325, and 330. This new standard has three major categories: Water Loop (comparable to ARI 320), Ground Water (ARI 325), and Ground Loop (ARI 330). Although these standards are similar there are some differences:

Unit of Measure: The Cooling COP

The cooling efficiency is measured in EER (US version measured in Btuh per Watt. The Metric version is measured in a cooling COP (Watt per Watt) similar to the traditional COP measurement.

Water Conditions Differences

Entering water temperatures have changed to reflect the centigrade temperature scale. For instance the water loop heating test is performed with 68°F (20°C) water rounded down from the old 70°F (21.1°C).

Air Conditions Differences

Entering air temperatures have also changed (rounded down) to reflect the centigrade temperature scale. For instance the cooling tests are performed with 80.6°F (27°C) dry bulb and 66.2°F (19°C) wet bulb entering air instead of the traditional 80°F (26.7°C) DB and 67°F (19.4°C) WB entering air temperatures. 80.6/66.2 data may be converted to 80/67 using the entering air correction table. This represents a significantly lower relative humidity than the old 80/67 of 50% and will result in lower latent capacities.

Pump Power Correction Calculation

Within each model, only one water flow rate is specified for all three groups and pumping Watts are calculated using the following formula. This additional power is added onto the existing power consumption.

- Pump power correction = (gpm x 0.0631) x (Press Drop x 2990) / 300

Where 'gpm' is waterflow in gpm and 'Press Drop' is the pressure drop through the unit heat exchanger at rated water flow in feet of head.

Blower Power Correction Calculation

Blower power is corrected to zero external static pressure using the following equation. The nominal airflow is rated at a specific external static pressure. This effectively reduces the power consumption of the unit and increases cooling capacity but decreases heating capacity. These Watts are significant enough in most cases to increase EER and COPs fairly dramatically over ARI 320, 325, and 330 ratings.

- Blower Power Correction = (cfm x 0.472) x (esp x 249) / 300

Where 'cfm' is airflow in cfm and 'esp' is the external static pressure at rated airflow in inches of water gauge.

ISO Capacity and Efficiency Calculations

The following equations illustrate cooling calculations:

- ISO Cooling Capacity = Cooling Capacity (Btuh) + (Blower Power Correction (Watts) x 3.412)
- ISO EER Efficiency (W/W) = ISO Cooling Capacity (Btuh) x 3.412 / [Power Input (Watts) - Blower Power Correction (Watts) + Pump Power Correction (Watt)]

The following equations illustrate heating calculations:

- ISO Heating Capacity = Heating Capacity (Btuh) - (Blower Power Correction (Watts) x 3.412)
- ISO COP Efficiency (W/W) = ISO Heating Capacity (Btuh) x 3.412 / [Power Input (Watts) - Blower Power Correction (Watts) + Pump Power Correction (Watt)]

Comparison of Test Conditions

	ARI 320	ISO/AHRI 13256-1 WLHP	ARI 325	ISO/AHRI 13256-1 GWHP	ARI 330	ISO/AHRI 13256-1 GLHP
Cooling						
Entering Air - DB/WB °F	80/67	80.6/66.2	80/67	80.6/66.2	80/67	80.6/66.2
Entering Water - °F	85	86	50/70	59	77	77
Fluid Flow Rate	*	**	**	**	**	**
Heating						
Entering Air - DB/WB °F	70	68	70	68	70	68
Entering Water - °F	70	68	50/70	50	32	32
Fluid Flow Rate	*	**	**	**	**	**

Note *: Flow rate is set by 10°F rise in standard cooling test
Part load entering water conditions not shown.

Note **: Flow rate is specified by the manufacturer

WLHP = Water Loop Heat Pump; GWHP = Ground Water Heat Pump; GLHP = Ground Loop Heat Pump

Conversions:

Airflow (lps) = CFM x 0.472;

ESP (Pascals) = ESP (in wg) x 249;

WaterFlow (lps) = GPM x 0.0631;

Press Drop (Pascals) = Press Drop (ft hd) x 2990

Synergy3D Design Features



- ① **COMPRESSOR:** Copeland Scroll UltraTech™ (dual capacity) mounted on double isolation plates.
- ② **MICROPROCESSOR CONTROLS:** Premier microprocessor provides monitoring and control with fault, status and I/O LED indication for easy servicing.
- ③ **STATUS LIGHTS:** Mounted higher on the unit.
- ④ **COAXIAL HEAT EXCHANGER:** Standard copper (optional cupronickel) coax with our exclusive ThermaShield coating to prevent condensation and corrosion.
- ⑤ **AIR COIL:** Large aluminum fin/tube air coil is designed for maximum efficiency, moisture removal and provides superior protection from formicary corrosion.
- ⑥ **FILTER RACK:** Redesigned rack holds 1 in. or 2 in. filters (field changeable).
- ⑦ **FILTER:** High holding capacity 2 in. pleated MERV 11 filter is standard and 4 in. pleated MERV 11 is optional.
- ⑧ **INSULATION:** Cleanable foil lined insulation to prevent mold growth; corrosion resistant composite drain pan.
- ⑨ **CABINET FINISH:** Heavy gauge galvanized sheet metal cabinet has 1,000 hour salt spray rated powder coat paint for long life.
- ⑩ **CABINET STYLING ELEMENTS:** Rounded front corner posts with “Wave” trim piece and gold nameplate.
- ⑪ **ACCESS PANELS:** Lift out front bottom access panel, lift out panels for easier removal and servicing.
- ⑫ **HINGED CONTROL BOX:** Hinged removable control box.
- ⑬ **INTELLISTART:** Optional single phase soft starter reduces normal start current (LRA) by 60%, allows heat pump to more easily go “off grid,” provides substantial reduction in light flicker, reduces start-up noise, and improves compressor’s start behavior.
- ⑭ **DISCHARGE MUFFLER:** Helps quiet compressor gas pulsations (not shown).
- ⑮ **OPTIONAL HOT WATER ASSIST:** Provides free hot water in cooling and very high efficiency hot water generation in heating mode.
- ⑯ **VS ECM BLOWER MOTOR:** Variable speed ECM motors provide high efficiency and ultra-flexible air flows.

Synergy3D Design Features cont.

What's New?

- Copeland UltraTech™ Compressors in dual capacity units.
 - Modulating, switches from low to high without delay.
 - 67% capacity first stage.
 - Sizes 038, 049, 064, 072.
- Cabinet styling—corrosion resistant powder coated paint, rounded front corner posts, “wave” styling element, gold nameplate.
- Standard 2 in. filter rack switchable to 1 in.
- Foil lined cleanable insulation.
- Double isolation mounted compressors.
- Hinged, removable control box.
- Improved air coil service access.
- Graduated cabinet heights fits as replacement for 100,000+ installed Premier units.
- Aluminum tube and fin high performance air coil.
- Optional hot water generator (without factory installed pump) can generate heated water at considerable savings.
- ThermaShield coated coaxial heat exchangers
- Discharge line muffler helps quiet compressor discharge gas pulsations.

Application Flexibility

- Safe, efficient operation in a wide range of liquid temperatures (20°F to 120°F) and flow rates (as low as 1.5 GPM/ton in open loop applications when EWT >50°F).
- Top and rear air discharge for upflow installations in vertical units.
- True left or right return air locations—units include filter rack/duct collar.
- Variable speed ECM blowers permit various duct applications.
- Narrow cabinet for easy movement through doorways.
- Internally trapped condensate piping for neat, compact installation.
- Optional field-installed auxiliary electric heater.
- Corner-located electrical box for field wiring from two sides.
- Fuse-protected loop pump power block for easy wiring.
- Loop pump linking feature allows multiple units to share one flow center.
- Field-selectable low source water temperature limit setting for well or closed loop systems.
- Relays to control field-mounted air dampers.

Operating Efficiencies

- AHRI/ISO 13256-1 rating for heating COPs, cooling EERs and low water flow requirements.
- High-stability expansion valve delivers optimum refrigerant flow over a wide range of conditions and provides bidirectional operation without troublesome check valves.
- Efficient scroll compressors operate quietly.
- Oversized coaxial tube water-to-refrigerant heat exchanger operates at low liquid pressure drops.
- Convoluted copper water tube functions efficiently at low flow rates.
- Oversized aluminum tube/lanced aluminum fin air-to-refrigerant heat exchanger provides high efficiencies at low-face velocity.
- Large, low-RPM blowers with variable-speed motors provide quiet and efficient air movement with high static capability.
- Utilizes the ozone-friendly R-410A refrigerant which produces higher efficiencies and warmer discharge air temperatures.

Service Advantages

- Hinged, removable control box for added serviceability.
- Removable panels: three for the compressor compartment and two for the air handling compartment to provide quick access to all internal components with ductwork in place.
- Easily accessible thermal expansion valve.
- Brass, swivel-type water connections for quick connection union, and elimination of wrenches and sealants during installation.
- Insulated divider and separate air handling/compressor access panels permit service testing without air bypass.
- Designed for front access in tight applications.
- LED fault and status lights with memory for easy diagnostics.
- Detachable thermostat connection strip for wiring convenience.
- Hot water pump shut-off switch for easy startup and service.
- Control box and blower motors have quick-attach wiring plugs for easy removal.
- Internal drop-out blower with permanently-lubricated ball bearing motor.
- High- and low-pressure service ports in refrigerant circuit.
- Blower and transformer powered from auxiliary heat supply (when installed) to provide emergency heat with open compressor circuit breaker.

Synergy 3D Design Features cont.

Product Quality

- Heavy-gauge steel cabinets are painted with durable powder coat paint for long lasting beauty and service.
- Coaxial heat exchanger, refrigerant suction lines, hot water generator coil, and source water pipes are fully insulated to reduce condensation problems in low temperature operation.
- Aluminum tube/fin air coils for protection from formicary corrosion.
- Noise reduction features include double isolation mounted compressors, discharge muffler, and soft starting blower motors; insulated compressor compartment; interior cabinet insulation using 1/2-inch coated glass fiber. All units include compressor blanket for quiet operation.
- Safety features include high- and low-pressure refrigerant controls to protect the compressor; condensate overflow protection; freeze detection sensor to safeguard the coaxial heat exchanger; blower start detection; fault lockout enables emergency heat and prevents compressor operation until thermostat or circuit breaker is reset.

Microprocessor Benefits

- Digital auto-changeover thermostat with 3-stage heating/2-stage cooling holds precise temperature and provides varying blower speed control.
- Component sequencing delays for quiet startup, shutdown, and timed staging of auxiliary electric heat.
- Variable speed ECM blower speed control provides higher supply air temperature in heating, better dehumidification in cooling, and quiet operation at reduced airflows in all modes.

Options and Accessories

- Cupronickel heat exchangers for open loop applications
- Optional hot water generator without factory mounted pump.
- Optional oversized ECM blower motor for high static applications on O38 to O49 models.
- Electronic auto-changeover thermostat with 3-stage heating/2-stage cooling and indicator LEDs.
- 24 volt 1-inch electronic air cleaner.
- 90% efficient, cleanable electrostatic filters.
- Closed loop flow center.
- Auxiliary electric heater.
- Hose kits.
- AlpinePure 2 in. MERV 13 filter
- AlpinePure 4 in. MERV 11 filter and rack
- IntelliStart™ soft starter

Manufacturing Quality

- All units are computer run-tested, with conditioned source water, in all modes to insure efficiency and reliability.
- All refrigerant brazing is performed in a nitrogen atmosphere.
- All units are deep evacuated to less than 150 microns prior to refrigerant charging.
- All joints are helium leak-tested to insure an annual leak rate of less than 1/4 ounce.
- All major components bar coded. Eliminating possibility of mismatched parts built into unit.
- All assembly technicians thoroughly trained in proper quality procedures.
- Focus on geothermal products enables company to dedicate all resources to product.

Microprocessor Control

Startup

The unit will not operate until all the inputs and safety controls are checked for normal conditions. At first power-up, a four minute delay is employed before the compressor is energized.

Component Sequencing Delays

Components are sequenced and delayed for optimum space conditioning performance.

Accessory Relay

The accessory relay will be used to control a refrigerant solenoid valve. The accessory relay will turn on when the control is operating in forced air heating, forced air cooling and when there is no active thermostat input. The relay will be off when operating in hot water mode.

Loop Pump Linking Signals

A signal between multiple Synergy3D control boards at the inputs and outputs (SL1-In and Out) will provide for remote control of the loop pump on any unit.

Condensate Overflow Protection

The control board incorporates an impedance sensing liquid sensor at the top of the drain pan. Upon a continuous 30-second sensing of the condensate, compressor operation is suspended (see Fault Retry), and the condensate overflow lockout LED begins flashing.

Shutdown Mode

A 24VAC **Common** signal to the “shutdown” input on the control board puts the unit into shutdown mode. Compressor, hot water pump, and blower operation are suspended.

Short Cycle Protection

The control employs a minimum “off” time of four minutes and a minimum “on” time of two minutes for short cycle protection of the compressor.

Safety Controls

The control receives separate signals for a high pressure switch for safety, a low pressure switch to prevent loss of charge damage, and a low suction temperature thermistor for freeze detection limit. Upon a continuous 30-second measurement of the fault (immediate for high pressure), compressor operation is suspended, the appropriate lockout LED begins flashing. (Refer to the “Fault Retry” section.)

Testing

The control allows service personnel to shorten most timing delays for faster diagnostics (Refer to Dip Switch description).

Fault Retry

All faults (except for low RPM faults with the ECM blower motor) are retried twice before finally locking the unit out. An output signal is made available for a fault LED at the thermostat. The “fault retry” feature is designed to prevent nuisance service calls.

Diagnostics

The control board allows all inputs and outputs to be displayed on the LEDs for fast and simple control board diagnosis. (Refer to Dip Switch description).

Resistance Heat Control (208-230 Units)

The electric heat control module contains the appropriate high-voltage control relays. Control signals energize the relays in the proper sequence, and the LED display board indicates which stages are energized.

IntelliStart

Some models shall be equipped with an optional IntelliStart. IntelliStart is a single-phase soft starter which reduces the normal start current (LRA) by 60%. This allows the heat pump to more easily go “off-grid.” Using IntelliStart will also provide a substantial reduction in light flicker, reduce startup noise, and improve the compressor’s start behavior. The IntelliStart is self-calibrating and may take several starts to optimize the compressor start behavior.

Features:

- Automatic adjustment of the compressor starting current to the available supply voltage —maintaining constant starting torque and current.
- Supply line impedance monitoring and compensation.
- Automatic compensation for residual backpressure in the system.
- Monitoring of supply voltage while compressor is running to prevent motor stalling, causing excessive currents, under low voltage conditions.
- Light flicker reductions of up to 10:1 over LRA under the same conditions.

ECM Airflow Selection DIP Switches (SW1)

A 12-position DIP switch package on the Synergy3D control allows the airflow levels to be set for low, medium and high speed when using the variable speed ECM blower motor (see Synergy3D Blower Performance table).

Microprocessor Control cont.

Heating Operation

Heat, 1st Stage (Y1)

The blower motor is started on low speed immediately, the loop pump is energized 5 seconds after the "Y1" input is received, and the compressor is energized on low capacity 10 seconds after the "Y1" input. The ECM blower is switched to medium speed 15 seconds after "Y1" input.

Heat, 2nd Stage (Y1,Y2) Dual Capacity Units

The second stage compressor will be activated 5 seconds after receiving a "Y2" input as long as the minimum first stage compressor run time of 1 minute has expired. The ECM blower changes from medium to high speed 15 seconds after the "Y2" input.

Heat, 3rd Stage (Y1,Y2,W) Dual Capacity Units

The 1st stage of resistance heat is energized 10 seconds after "W" input, and with continuous 3rd stage demand, the second stage of resistance heat will engage after 5 minutes.

Emergency Heat (W Only)

Low speed blower and damper output CR3 will be energized immediately after receiving (W only). The first stage auxiliary heater will be energized 10 seconds upon receiving a (W only) and the blower will shift to high speed 15 seconds after receiving a "W" only input. If the "W" input is not removed, the second, auxiliary heat output will stage on after two minutes.

Cooling Operation

Cool, 1st Stage (Y1,O)

The blower is started immediately, and the loop pump(s) is energized 5 seconds after the "Y1" input is received. The compressor will be energized on low capacity 10 seconds after the "Y1" input. The ECM blower will shift from low to medium speed 15 seconds after the "Y1" input.

Cool, 2nd Stage (Y1, Y2, O) Dual Capacity Units

The second stage compressor will be activated 5 seconds after receiving a "Y2" input as long as the minimum first stage compressor run time of 1 minute has expired. The ECM blower changes to high speed 15 seconds after the "Y2" input.

Hydronic Cooling Slave Signal (24 vac input on P6-pin 15 violet wire)

The Synergy3D control board must be operating in cooling mode (Y1 and O inputs) or the cooling slave signal is ignored. When "Y1", and "O" inputs have been received and a cooling slave input from heating/cooling thermostat located in a hydronic heated/force air cooled zone are received the control will activate CR3 relay to open damper(s) which will allow for cooling to occur in zone. When cooling slave input (24VAC) signal is removed the control will turn off the CR3 relay output, if spring damper operation is selected, or activate, the CR4 output if POPC damper operation is selected. This will close field installed damper(s) located in ductwork. **NOTE:** The control will not operate in forced air cooling and hydronic water heating modes simultaneously.

Hot Water Operation

After a hot water input is received, the diverting valve, loop pump and load water pump are turned on. Five seconds after hot water input is received the compressor is activated in second stage. Hydronic Mode Operation with Hydronic Priority Setting: If the control receives a demand to heat the space (Y1) from the thermostat during water heating mode operation, the control will engage Medium ECM fan speed and the first stage auxiliary heat output. The second stage will be energized at five (5) minutes, following the first stage. The installer should set medium ECM fan speed for no less than the minimum required cfm for the installed electric heat package (see Auxiliary Heat Ratings table).

Blower (G Only)

The blower starts on low speed. Regardless of blower input (G) from thermostat, the blower will remain on low speed for 30 seconds at the end of each heating, cooling or emergency heat cycle.

Lockout Conditions

During lockout mode the appropriate unit and thermostat lockout LEDs will illuminate. The compressor, loop pump, load water pump and accessory outputs are de-energized. Unless the lockout is caused by an ECM low RPM fault, the blower will continue to run on low speed, and if the thermostat calls for heating 3rd stage, emergency heat operation will occur.

Lockout modes can be reset at the thermostat after a five-second waiting period, which restores normal operation but keeps the unit lockout LED illuminated. Interruption of power to the unit will reset a lockout without a waiting period and clear all lockout LEDs.

High Pressure

This lockout mode occurs when the normally closed safety switch is opened momentarily. >600 PSI

Low Pressure

This lockout mode occurs when the normally closed switch is opened for 30 continuous seconds. <40 PSI

Freeze Detection Limit (Water Flow)

This lockout mode occurs when the low source water thermistor temperature is at or below the selected point (well 30°F or loop 15°F) for 30 continuous seconds.

ECM Blower RPM

The control board monitors blower RPM to sense if the blower is not operating. This lockout mode occurs if the blower RPM falls below the low RPM limit (100 RPM) for 30 continuous seconds.

Microprocessor Control cont.

Hydronic Operation

SW4 (Status Board Switch)

In the OFF position, the hydronic mode is disabled and the damper connected to CR3/CR4 is opened. The switch must be in the ON position to enable the hydronic mode. **NOTE:** If the status board is not connected to the main control board, the hydronic mode is disabled.



SW3 (4 and 5 Override Selection DIP Switches)

These DIP switches configure the time that the unit will run in the current mode of operation if it is not the priority mode (SW2 #3 FAH/Hydronics) of operation selected. Example: If the unit is operating in hydronic mode, forced air heat (SW2 #3 is OFF) is the priority. A Y1 call from the FAH zone is present at the control board. When SW3 numbers 4 and 5 are both in the ON position, the unit will operate in the hydronic mode for five minutes. If the hydronic call is not satisfied within the five minutes, the unit will switch to FAH mode. When FAH is satisfied, the unit will switch back to hydronic. (See Override Selection DIP Switches table.)

ComforTalk and FaultFlash Thermostats

When the heat pump microprocessor control is configured for ComforTalk or FaultFlash (SW2-8 'off') thermostats the thermostats will flash or display alert codes when a lockout condition is present. SW2-8 in the 'on' position configures the control to operate with typical thermostats (continuous lockout signal).

FaultFlash Thermostats

Thermostat Display Lockout Code	Lockout Description
2 Flashes	High Pressure Fault
3 Flashes	Low Pressure Fault
4 Flashes	Not Applicable
5 Flashes	Water Flow Fault
6 Flashes	Not Applicable
7 Flashes	Condensate Fault
8 Flashes	Voltage Out of Range
9 Flashes	RPM Fault

The tables below show the codes that will be displayed on the different ComforTalk and FaultFlash thermostats.

ComforTalk Thermostats

Thermostat Display Lockout Code	Lockout Description
"High Pressure" or "E2"	High Pressure Fault
"Low Pressure" or "E3"	Low Pressure Fault
"E4"	Not Applicable
"Water Flow" or "E5"	Water Flow Fault
"E6"	Not Applicable
"Condensate" or "E7"	Condensate Fault
"Voltage Range" or "E8"	Voltage Out of Range
"RPM" or "E9"	RPM Fault

These thermostats can be configured to display the lockout condition "text" or error number.

* A slow flash of 1 second on and off means the heat pump microprocessor SW2-1 is configured for "Test Mode".

Microprocessor Control cont.

Airflow Selection DIP Switches (SW1)

See Blower Performance Data section.

Factory Setup DIP Switches (SW2)				
DIP Switch Number		Description	OFF Position	ON Position
SW2-	1	Service Test Mode Allows field selection of "NORMAL" or "TEST" operational modes. Test mode accelerates most timing functions 16 times to allow faster troubleshooting. Test mode also allows viewing the "CURRENT" status of the fault inputs on the LED display.	Test Mode	Normal Speed Operation
SW2-	2	Freeze Detection Limit Allows field selection of freeze detection thermistor fault sensing for well water (30°F) or antifreeze protected (15°F) earth loops.	Low Loop Water Temperature Sensing Set at 15°F	Low Well Water Temperature Sensing Set at 30°F
SW2-	3	Forced Air Heating/Hydronic Heating This switch allows field selection of "Heating Forced Air Priority" or "Hydronic Priority".	Forced Air Heating Priority	Hydronic Heating Priority
SW2-	4	Forced Air Cooling/Hydronic Heating This switch allows field selection of "Cooling Forced Air Priority" or "Hydronic Priority".	Forced Air Cooling Priority	Hydronic Heating Priority
SW2-	5	Not Used	Not Applicable	Not Applicable
SW2-	6	Diagnostics Inputs Allows viewing the inputs from the thermostat to the control board such as Y1, Y2, O, G, W, HW, SL1-In, on the LED display..	Inputs	Normal
SW2-	7	Diagnostics Outputs Allows viewing the outputs from the control board such as compressor, diverting valve, reversing valve, blower, hot water pump and loop pump on the LED display.	Outputs	Normal
SW2-	8	Thermostat Selection Configures the control for a pulsed lockout signal (ComforTalk and FaultFlash thermostats) or continuous lockout signal (standard thermostat).	Pulse "L" Signal	Continuous "L" Signal

Factory Setup DIP Switches (SW3)				
DIP Switch Number		Description	OFF Position	ON Position
SW3-	1	Dual Capacity/Single Speed Configures the control for single speed compressor operation or dual capacity operation.	Dual Capacity Operation	Single Speed Operation
SW3-	2	POPC/Spring This switch allows field selection of "Power Open, Power Closed" dampers or "Power Open, Spring Close" dampers.	Power Open, Power Close	Power Open, Spring Close
SW3-	3	No RPM/RPM Configures the control to monitor the RPM output of an ECM blower motor. This product must have the control configured for "NO RPM" sensing.	ECM Blower/RPM Monitoring Disable	Not Used
SW3-	4	Override Time Configures the control override timings when switching from forced air mode to hydronic mode or vice versa.	See Override Selection table below for timings	See Override Selection table below for timings
SW3-	5	Override Time Configures the control override timings when switching from forced air mode to hydronic mode or vice versa.	See Override Selection table below for timings	See Override Selection table below for timings

LED Status Board DIP Switches (SW4)				
DIP Switch Number		Description	OFF Position	ON Position
SW4-	1	Hydronic Mode Enables and disables hydronic heating mode.	Hydronic Heating Disabled	Hydronic Heating Enabled

Override Selection DIP Switches

Override Time	SW3-4	SW3-5
5 minutes	On	On
10 minutes	Off	On
30 minutes	On	Off
60 minutes	Off	Off

Operation Logic

	Heating				Cooling		Hot Water Mode
	STG1	STG2	STG3	EMERG	STG1	STG2	
Compressor	On	On	On	Off	On	On	Stg 2 On
Reversing Valve	Off	Off	Off	Off	On	On	Off
Loop Pump	On	On	On	Off	On	On	On
Load Pump	Off	Off	Off	Off	Off	Off	On
Aux Heater	Off	Off	Staged	Staged	Off	Off	Off
Acc Relay	On	On	On	Off	On	On	Off
Diverting Valve	Off	Off	Off	Off	Off	Off	On
ECM Speed	On	On	On	On	On	On	Off
T-Stat Signal	Y1	Y1, Y2	Y1, Y2, W	W	Y1, O	Y1, Y2, O	HW
Damper	Off	Off	Off	On	Off	Off	Off
Auxiliary 1 - Out	On	On	On	Off	On	On	On

Water Quality

It is the responsibility of the system designer and installing contractor to ensure that acceptable water quality is present and that all applicable codes have been met in these installations. Failure to adhere to the guidelines in the water quality table could result in loss of warranty. In ground water situations where scaling could be heavy or where biological growth such as iron bacteria will be present, a closed loop system is recommended. The heat exchanger coils in ground water systems may, over a period of time, lose heat exchange capabilities due to a buildup of mineral deposits inside. These can be cleaned, but only by a qualified service mechanic, as special solutions and pumping equipment are required. Hot water generator coils can likewise become scaled and possibly plugged. In areas with extremely hard water, the owner should be informed that the heat exchanger may require occasional flushing.

Units with cupronickel heat exchangers are recommended for open loop applications due to the increased resistance to build-up and corrosion, along with reduced wear caused by acid cleaning. Failure to adhere to the guidelines in the water quality table could result in the loss of warranty.

Water Treatment

Do not use untreated or improperly treated water. Equipment damage may occur. The use of improperly treated or untreated water in this equipment may result in scaling, erosion, corrosion, algae or slime. Purchase of a pre-mix antifreeze could significantly improve system reliability if the water quality is controlled and there are additives in the mixture to inhibit corrosion. There are many examples of such fluids on the market today such as Environol™ 1000

(pre-mix ethanol), and others. The services of a qualified water treatment specialist should be engaged to determine what treatment, if any, is required. The product warranty specifically excludes liability for corrosion, erosion or deterioration of equipment.

The heat exchangers and water lines in the units are copper or cupronickel tube. There may be other materials in the buildings piping system that the designer may need to take into consideration when deciding the parameters of the water quality. If antifreeze or water treatment solution is to be used, the designer should confirm it does not have a detrimental effect on the materials in the system.

Contaminated Water

In applications where the water quality cannot be held to prescribed limits, the use of a secondary or intermediate heat exchanger is recommended to separate the unit from the contaminated water. The table above outlines the water quality guidelines for unit heat exchangers. If these conditions are exceeded, a secondary heat exchanger is required. Failure to supply a secondary heat exchanger where needed will result in a warranty exclusion for primary heat exchanger corrosion or failure.

Material		Copper	90/10 Cupronickel	316 Stainless Steel
pH	Acidity/Alkalinity	7 - 9	7 - 9	7 - 9
Scaling	Calcium and Magnesium Carbonate	(Total Hardness) less than 350 ppm	(Total Hardness) less than 350 ppm	(Total Hardness) less than 350 ppm
Corrosion	Hydrogen Sulfide	Less than 0.5 ppm (rotten egg smell appears at 0.5 ppm)	10 - 50 ppm	Less than 1 ppm
	Sulfates	Less than 125 ppm	Less than 125 ppm	Less than 200 ppm
	Chlorine	Less than 0.5 ppm	Less than 0.5 ppm	Less than 0.5 ppm
	Chlorides	Less than 20 ppm	Less than 125 ppm	Less than 300 ppm
	Carbon Dioxide	Less than 50 ppm	10 - 50 ppm	10 - 50 ppm
	Ammonia	Less than 2 ppm	Less than 2 ppm	Less than 20 ppm
	Ammonia Chloride	Less than 0.5 ppm	Less than 0.5 ppm	Less than 0.5 ppm
	Ammonia Nitrate	Less than 0.5 ppm	Less than 0.5 ppm	Less than 0.5 ppm
	Ammonia Hydroxide	Less than 0.5 ppm	Less than 0.5 ppm	Less than 0.5 ppm
	Ammonia Sulfate	Less than 0.5 ppm	Less than 0.5 ppm	Less than 0.5 ppm
	Total Dissolved Solids (TDS)	Less than 1000 ppm	1000 - 1500 ppm	1000 - 1500 ppm
LSI Index	+0.5 to -0.5	+0.5 to -0.5	+0.5 to -0.5	
Iron Fouling (Biological Growth)	Iron, FE ²⁺ (Ferrous) Bacterial Iron Potential	< 0.2 ppm	< 0.2 ppm	< 0.2 ppm
	Iron Oxide	Less than 1 ppm, above this level deposition will occur	Less than 1 ppm, above this level deposition will occur	Less than 1 ppm, above this level deposition will occur
Erosion	Suspended Solids	Less than 10 ppm and filtered for max. of 600 micron size	Less than 10 ppm and filtered for max. of 600 micron size	Less than 10 ppm and filtered for max. of 600 micron size
	Threshold Velocity (Fresh Water)	< 6 ft/sec	< 6 ft/sec	< 6 ft/sec

NOTES: Grains = ppm divided by 17
mg/L is equivalent to ppm

2/22/12

Application Information

Synergy3D units provide ducted heating and cooling, and hot water to radiant floor applications.

Most Synergy3D applications use multiple thermostats for heating. One or more thermostats may be dedicated to the forced air zone(s) while separate thermostats are used in the radiant floor zones. The microprocessor control in the unit allows for priority selection for either radiant or forced air zones, depending on the size, location and use of each zone.

Although the unit does not heat air and water simultaneously, the comfort “system” should be designed and controlled so that both functions occur simultaneously. This is achieved using a holding tank (buffer tank) for hot water. The buffer tank acts as a storage device for water heated using the Synergy3D unit. Warm water can be drawn from the buffer tank during forced air heating operation. At some point, the unit will need to switch from forced air heating mode to water heating mode when the temperature of the buffer tank drops below the setpoint. This switchover will occur either before or after the ducted zones are satisfied in heating, depending on the prioritization.

Typical water temperatures in radiant floor heating systems are around 100-105° F (38-40° C). Heat pumps using R-410A refrigerant are not designed to produce water above 130° F (54° C). The system efficiency decreases as the temperature difference (TD) between the heat source (generally the earth loop) and the supply water (the distribution system) increases. The heating capacity of the heat pump also decreases as the temperature difference increases.

Figure 2: Air Flow for Ducted Zones, and Water Flow for Radiant Zones

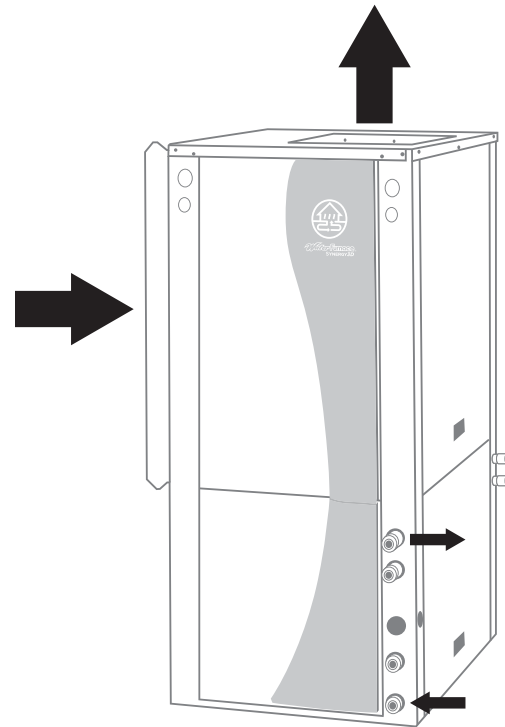

When designing radiant floor distribution systems, the temperature limits of the geothermal system must be a major consideration. In new construction, the distribution system can easily be designed with the temperature limits in mind. In retrofits, care must be taken to address the operating temperature limits of the existing distribution system.

Figure 1: Radiant Floor Heating



Application Information cont.

Radiant Floor Heating

Radiant floor heating has been the system of choice in many parts of Europe for some time. Manufacturers have developed tubing designed for installation in concrete floors and built-up wood floors. Floor heating systems have several benefits in residential, commercial and industrial heating applications. In a building with a radiant floor heating system, the entire floor acts as a heat source for the room.

In residential applications, occupants in a space feel comfortable with lower air temperatures if their feet are warm. Typically the space will feel comfortable with air temperatures as low as 65° F (18° C). Since the heat loss of a building is directly related to the temperature difference between the inside and outside, a lower temperature difference means the heat loss is lower. Air temperatures in a room with a forced air heating system tend to be warmer near the ceiling than the floor. The hot air rises and creates a greater pressure imbalance between the inside and outside. The building's infiltration increases, resulting in a higher heat loss. Air temperatures in a room with floor heating tend to be warmer at the floor than the ceiling, helping cut down on infiltration in the building. The energy savings in a building with floor heating can range from 20-40% over traditional forced air systems.

Temperatures in a forced air system tend to be more uneven than in a radiant floor heating system. The air temperatures in a forced air system tend to be much higher than with radiant floor heating, making the temperature difference between inside and outside higher, which results in a higher BTU requirement.

Hydronic/geothermal systems can be used very effectively in new installations, as well as in many retrofit applications. Efficient systems can be built for residential, commercial and industrial applications.

To make a system as efficient as possible, it is important to follow good design criteria. Some of the factors to consider are listed below:

- An accurate heat loss and heat gain calculation must be done to size the system to operate efficiently.
- The system must meet the application requirements. In other words, the design of the system must take into consideration the type of distribution system and the needs of the customer.
- The components of the system must be designed to work together. The loop must be designed to work with the heat pumps, the pumping system must work efficiently with the earth loop and the heat distribution, and the distribution system must be chosen to work efficiently with the water temperatures available from the equipment.
- The system must be controlled to operate as efficiently as possible. It is important to operate the system to take variations in the building loads into account. For example, the heat loss of the building is reduced when the outdoor temperature climbs, and the temperature of the water circulated through the distribution system can be lowered, allowing the heat pumps to operate more efficiently.
- Modulating the various components of a system to meet the varying requirements of a building can significantly improve the efficiency of a system. Variable-speed pumps, for example, can greatly increase the overall efficiency of a system.
- The cost-effectiveness of the system must be considered. Regardless of the application, the design must take into account operating costs, installation costs and future repair/maintenance costs.

Figure 3 - Air Temperature Variations

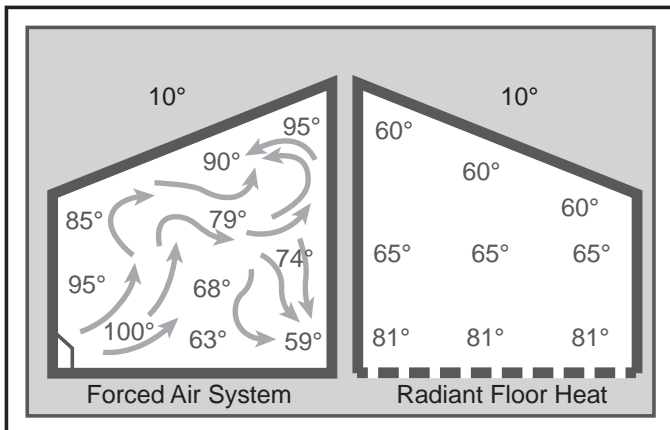

Dimensional Data

Topflow Discharge

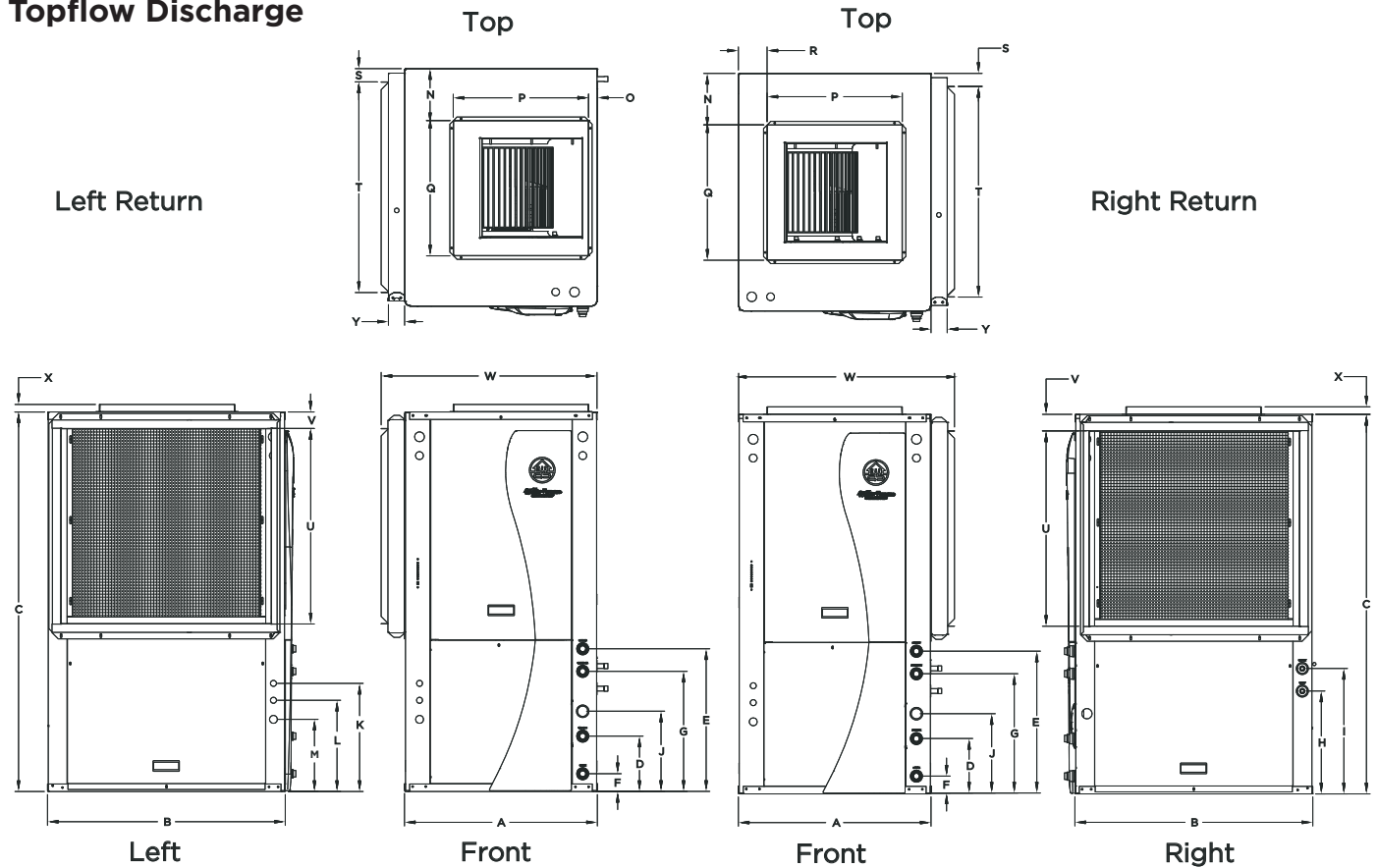

Vertical Topflow Model	Overall Cabinet			Water Connections										Electrical Connections			
	A	B	C	D	E	F	G	H	I	J	Loop Water FPT	Hydronic Water FPT	HWG Sweat (I.D.)	K	L	M	
	Width	Depth	Height	Loop In	Hydronic Out	Hydronic In	Loop Out	HWG In	HWG Out	Condensate				Low Voltage	Ext Pump	Power Supply	
038	in. cm.	25.6 65.0	31.6 80.3	50.4 128.0	7.3 18.5	18.9 48.0	2.3 5.8	15.9 40.4	13.6 34.5	16.6 42.2	10.6 26.9	1" Swivel	1" Swivel	1/2" Female	14.4 36.6	12.1 30.7	9.6 24.4
049	in. cm.	25.6 65.0	31.6 80.3	54.4 138.2	7.3 18.5	18.9 48.0	2.3 5.8	15.9 40.4	15.9 40.4	18.9 48.0	10.6 26.9	1" Swivel	1" Swivel	1/2" Female	14.4 36.6	12.1 30.7	9.6 24.4
064	in. cm.	25.6 65.0	31.6 80.3	58.4 148.3	7.3 18.5	18.9 48.0	2.3 5.8	15.9 40.4	15.9 40.4	18.9 48.0	10.6 26.9	1" Swivel	1" Swivel	1/2" Female	14.4 36.6	12.1 30.7	9.6 24.4
072	in. cm.	25.6 65.0	31.6 80.3	58.4 148.3	7.3 18.5	18.9 48.0	2.3 5.8	15.9 40.4	15.9 40.4	18.9 48.0	10.6 26.9	1" Swivel	1" Swivel	1/2" Female	14.4 36.6	12.1 30.7	9.6 24.4

Discharge Connection duct flange installed (±0.10 in)				Return Connection using standard deluxe filter rack (±0.10 in)						Misc	
N	O	P Supply Width	Q Supply Depth	R	S	T Return Depth	U Return Height	V	W	X	Y
6.9 17.5	1.1 2.8	18.0 45.7	18.0 45.7	3.8 9.7	1.7 4.3	28.1 71.4	26.0 66.0	2.2 5.6	28.7 72.9	1.0 2.5	2.1 5.3
6.9 17.5	1.1 2.8	18.0 45.7	18.0 45.7	3.8 9.7	1.7 4.3	28.1 71.4	30.0 76.2	2.2 5.6	28.7 72.9	1.0 2.5	2.1 5.3
6.9 17.5	1.1 2.8	18.0 45.7	18.0 45.7	3.8 9.7	1.7 4.3	28.1 71.4	34.0 86.4	2.2 5.6	28.7 72.9	1.0 2.5	2.1 5.3
6.9 17.5	1.1 2.8	18.0 45.7	18.0 45.7	3.8 9.7	1.7 4.3	28.1 71.4	34.0 86.4	2.2 5.6	28.7 72.9	1.0 2.5	2.1 5.3

Condensate is 3/4 in. PVC female glue socket and is switchable from side to front
 Unit shipped with deluxe 2 in. (field adjustable to 1 in.) duct collar/filter rack extending from unit 3.25 in. and is suitable for duct connection.
 Discharge flange is field installed and extends 1 in. [25.4 mm] from cabinet
 Decorative molding and water connections extend 1.2 in. [30.5 mm] beyond front of cabinet.

10/16/13

Dimensional Data cont.

Rear Discharge

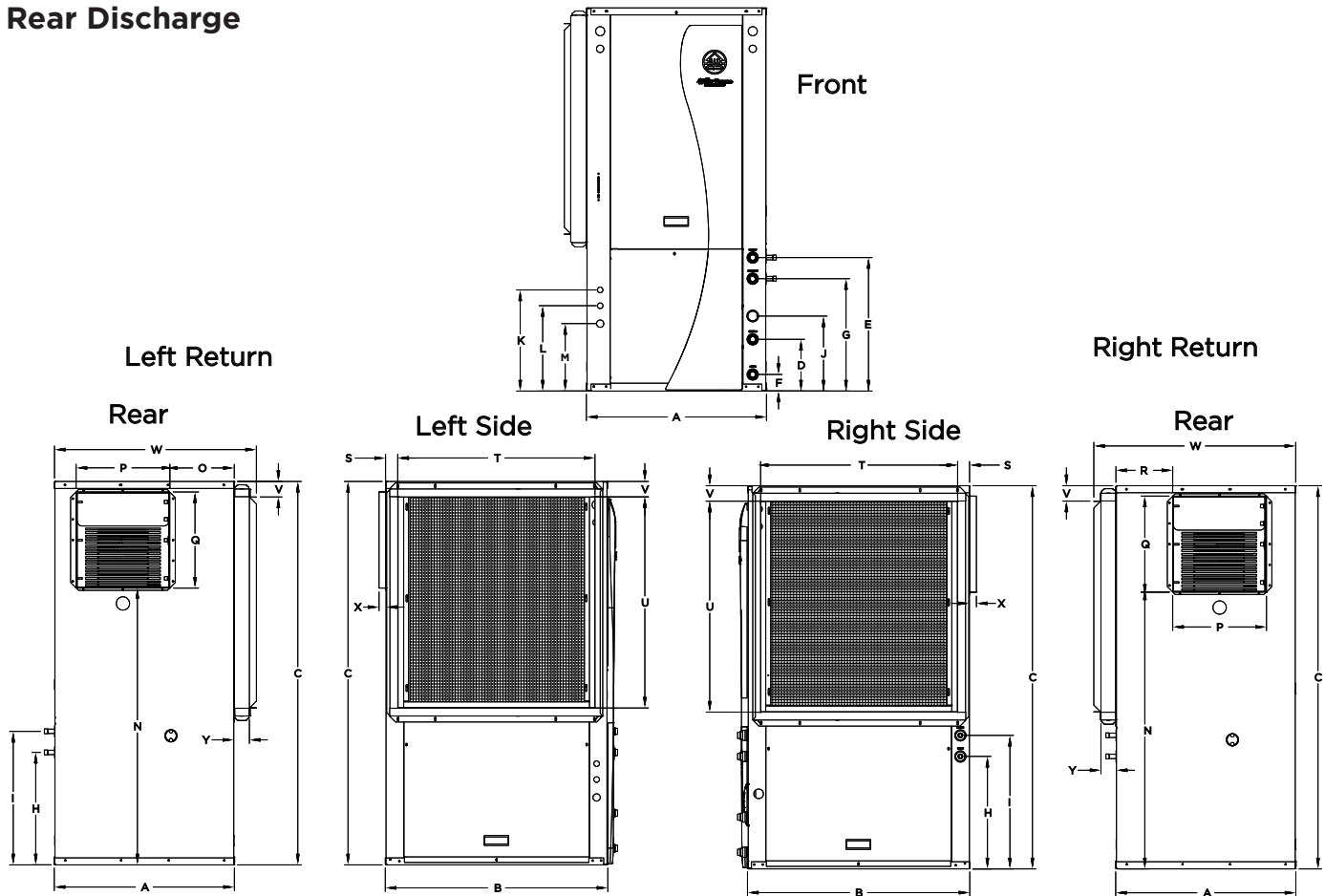

Vertical Backflow Model	Overall Cabinet			Water Connections											Electrical Connections		
	A Width	B Depth	C Height	D Loop In	E Hydronic Out	F Hydronic In	G Loop Out	H HWG In	I HWG Out	J Condensate	Loop Water FPT	Hydronic Water FPT	HWG Sweat (I.D.)	K 1/2" cond	L 1/2" cond	M 3/4" cond	
														Low Voltage	Ext Pump	Power Supply	
049	in. cm.	25.6 65.0	31.6 80.3	54.4 138.2	7.3 18.5	18.9 48.0	2.3 5.8	15.9 40.4	15.9 40.4	18.9 48.0	10.6 26.9	1" Swivel	1" Swivel	1/2" Female	14.4 36.6	12.1 30.7	9.6 24.4
064	in. cm.	25.6 65.0	31.6 80.3	58.4 148.3	7.3 18.5	18.9 48.0	2.3 5.8	15.9 40.4	15.9 40.4	18.9 48.0	10.6 26.9	1" Swivel	1" Swivel	1/2" Female	14.4 36.6	12.1 30.7	9.6 24.4
072	in. cm.	25.6 65.0	31.6 80.3	58.4 148.3	7.3 18.5	18.9 48.0	2.3 5.8	15.9 40.4	15.9 40.4	18.9 48.0	10.6 26.9	1" Swivel	1" Swivel	1/2" Female	14.4 36.6	12.1 30.7	9.6 24.4

Discharge Connection duct flange installed (±0.10 in)					Return Connection using std deluxe filter rack (±0.10 in)					Misc	
N	O	P Supply Width	Q Supply Depth	R	S	T Return Depth	U Return Height	V	W	X	Y
39.4	9.1	13.3	13.6	8.1	1.7	28.1	30.0	2.2	28.7	1.0	2.1
100.1	23.1	33.8	34.5	20.6	4.3	71.4	76.2	5.6	72.9	2.5	5.3
43.4	9.1	13.3	13.6	8.1	1.7	28.1	34.0	2.2	28.7	1.0	2.1
110.2	23.1	33.8	34.5	20.6	4.3	71.4	86.4	5.6	72.9	2.5	5.3
43.4	9.1	13.3	13.6	8.1	1.7	28.1	34.0	2.2	28.7	1.0	2.1
110.2	23.1	33.8	34.5	20.6	4.3	71.4	86.4	5.6	72.9	2.5	5.3

10/16/2013

Condensate is 3/4 in. PVC female glue socket and is switchable from side to front
 Unit shipped with deluxe 2 in. (field adjustable to 1 in.) duct collar/filter rack extending from unit 3.25 in. and is suitable for duct connection.
 Discharge flange is field installed and extends 1 in. [25.4 mm] from cabinet
 Decorative molding and water connections extend 1.2 in. [30.5 mm] beyond front of cabinet.

Physical Data

Model	038	049	064	072
Compressor (1 each)	Copeland Scroll			
Factory Charge R410a, oz [kg]	82 [2.32]	102 [2.89]	120 [3.40]	120 [3.40]
ECM Fan Motor & Blower				
Fan Motor Type/Speeds	Variable Speed ECM			
Fan Motor- hp [W]	1/2 [373]	1/2 [373]	1 [746]	1 [746]
Blower Wheel Size (Dia x W), in. [mm]	11 x 10 [279 x 254]	11 x 10 [279 x 254]	11 x 10 [279 x 254]	11 x 10 [279 x 254]
Coax and Water Piping				
Loop Water Connections Size - Swivel - in [mm]	1" [25.4]	1" [25.4]	1" [25.4]	1" [25.4]
Hydronic Water Connections Size - Swivel - in [mm]	1" [25.4]	1" [25.4]	1" [25.4]	1" [25.4]
HWG Connection Size - Female Sweat (I.D.) - in [mm]	1/2" [12.7]	1/2" [12.7]	1/2" [12.7]	1/2" [12.7]
Coax & Piping Water Volume - gal [l]	1.3 [4.9]	1.6 [6.1]	1.6 [6.1]	1.6 [6.1]
Vertical				
Air Coil Dimensions (H x W), in. [mm]	28 x 25 [711 x 635]	32 x 25 [813 x 635]	36 x 25 [914 x 635]	36 x 25 [914 x 635]
Air Coil Total Face Area, ft ² [m ²]	4.9 [0.451]	5.6 [0.570]	6.3 [0.641]	6.3 [0.641]
Air Coil Tube Size, in [mm]	3/8 [9.5]	3/8 [9.5]	3/8 [9.5]	3/8 [9.5]
Air Coil Number of rows	3	3	4	4
Filter Standard - 2" [51mm] Pleated MERV11 Disposable, in [mm]	28 x 30 [712 x 762]	32 x 30 [813 x 762]	36 x 30 [914 x 762]	36 x 30 [914 x 762]
Weight - Operating, lb [kg]	425	530	540	540
Weight - Packaged, lb [kg]	445	550	560	560

3/15/17

Auxiliary Heat

Auxiliary Heat Electrical Data

Model	Supply Circuit	Heater Amps		Min Circuit Amp		Max Fuse (USA)		Max Fuse (CAN)		Max CKT BRK	
		208V	240V	208V	240V	208V	240V	208V	240V	208V	240V
EAL(H)10A	Single	34.7	40	53.3	60	60	60	60	60	60	60
EAL(H)15A	Single	52.0	60	75	85	80	90	80	90	70	100
	L1/L2	34.7	40	53.3	60	60	60	60	60	60	60
	L3/L4	17.3	20	21.7	25	25	25	25	25	20	30
EAL(H)20A	Single	69.3	80	96.7	110	100	110	100	110	100	100
	L1/L2	34.7	40	53.3	60	60	60	60	60	60	60
	L3/L4	34.7	40	43.3	50	45	50	45	50	40	50

All heaters rated single phase 60 cycle and include unit fan load

All fuses type "D" time delay (or HACR circuit breaker in USA)

Vertical rear discharge models use the horizontal (EALH) auxiliary heat kit

Auxiliary Heat Ratings

Model	KW		Stages	BTU/HR		Min CFM	Compatibility			
	208V	230V		208V	230V		038	049	064	072
EAL10A	7.2	9.6	2	24,600	32,700	1100	•	•	•	•
EAL15A	10.8	14.4	3	36,900	49,100	1250	•	•	•	•
EAL20A	14.4	19.2	4	49,200	65,500	1500		•	•	•

NOTES: The heat pump requires Medium and High blower setting to be above the minimum CFM for the heater selected.
Rear discharge uses the horizontal auxiliary heat kits, EALH10A, 15A, or 20A.

5/6/09

Electrical Data

Model	Rated Voltage	Voltage Min/Max	Compressor				Int Pump FLA	Ext Loop FLA	Blower Motor FLA	Total Unit FLA	Min Circ Amp	Max Fuse/HACR
			MCC	RLA	LRA	LRA**						
038	208-230/60/1	187/253	23.8	15.2	83.0	30.0	1.07	5.4	4.0	25.7	29.5	40
038*	208-230/60/1	187/253	23.8	15.2	83.0	30.0	1.07	5.4	7.0	28.7	32.5	45
049	208-230/60/1	187/253	33.0	21.1	104.0	37.0	1.07	5.4	4.0	31.6	36.8	50
049*	208-230/60/1	187/253	33.0	21.1	104.0	37.0	1.07	5.4	7.0	34.6	39.9	60
064	208-230/60/1	187/253	42.3	27.1	152.9	54.0	1.07	5.4	7.0	40.5	47.3	70
072	208-230/60/1	187/253	46.3	29.6	179.2	63.0	1.07	5.4	7.0	43.1	50.5	80

Rated Voltage of 208-230/60/1.
 HACR circuit breaker in USA only.
 Local electrical codes overrule any wiring recommendations.
 * With optional 1 HP ECM motor
 **With optional IntelliStart

Min/Max Voltage of 187/253.
 All fuses Class RK-5.

09/24/13

Blower Performance Data

Model	Max ESP	Air Flow Dip Switch Settings											
		1	2	3	4	5	6	7	8	9	10	11	12
038	0.50	650	750 L	850	1000	1100 M	1200	1300 H	1400	1500			
038 w/1hp*	0.75	800 L	1000	1100 M	1300 H	1500	1600	1800					
049	0.50	650	800 L	900	1050	1150	1250	1350 M	1450	1550 H			
049 w/1hp*	0.75	800 L	900	1000	1200	1400 M	1600 H	1700	1850	2000	2200	2300	2400
064	0.75	800	950 L	1100	1300	1500 M	1750	1950 H	2100	2300			
072	0.75	800	950	1100 L	1300	1500	1750	1950	2100	2300			

Factory settings are at recommended L-M-H DIP switch locations
 M-H settings MUST be located within boldface CFM range
 Lowest and Highest DIP switch settings are assumed to be L and H respectively

CFM is controlled within 35% up to the maximum ESP
 Max ESP includes allowance for wet coil and standard filter

A 12-position DIP switch package on the heat pump control allows the airflow levels to be set for Low, Medium and High speed when using the variable speed ECM blower motor.

Only three of the DIP switches can be in the “On” position. The first “On” switch (the lowest position number) determines the “Low Speed Blower” setting. The second “On” switch determines the “Medium Speed Blower” setting, and the third “On” switch determines the “High Speed Blower” setting.

The example to the right shows SW1 on the heat pump control board configured for the following 049 airflow settings:

- Low Speed Blower: 800 CFM
- Medium Speed Blower: 1350 CFM
- High Speed Blower: 1550 CFM

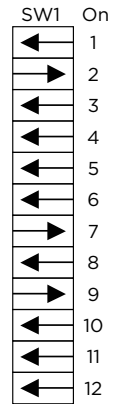

Reference Calculations

Heating Calculations:	Cooling Calculations:
$LWT = EWT - \frac{HE}{GPM \times 500}$	$LWT = EWT + \frac{HR}{GPM \times 500}$
$LAT = EAT + \frac{HC}{CFM \times 1.08}$	$LAT (DB) = EAT (DB) - \frac{SC}{CFM \times 1.08}$
$TH = HC + HW$	$LC = TC - SC$
	$S/T = \frac{SC}{TC}$

Legend and Notes

ABBREVIATIONS AND DEFINITIONS

CFM	= airflow, cubic feet/minute	KW	= kilowatts
COP	= coefficient of performance = (btu output/btu input) = $[HC/(kw \times 3.413)]$	LAT	= leaving air temperature °F
EAT	= entering air temperature °F	LC	= latent cooling capacity in MBTUH
EER	= energy efficiency ratio = btu output / watt input	LGPM	= load flow in gallons per minute
ELT	= entering load fluid temperature to heat pump	LLT	= leaving load fluid temperature from heat pump
EST	= entering source fluid temperature to heat pump	LST	= leaving source fluid temperature from heat pump
EWT	= entering water temperature (source) to heat pump	LWPD	= load coax water pressure drop
FT HD	= pressure drop in feet of head	LWT	= leaving water temperature °F
GPM	= gallons per minute	PSI	= pressure drop in pounds per square inch
HC	= total heating capacity in MBTUH	S/T	= sensible to total cooling ratio
HE	= heat extracted in MBTUH	SC	= sensible cooling capacity in MBTUH
HR	= heat rejected in MBTUH	SWPD	= source coax water pressure drop
		TC	= total cooling capacity in MBTUH
		TH	= total heating capacity in MBTUH
		WPD	= water pressure drop in PSI, feet of water

Notes to Performance Data Tables

The following notes apply to all *Performance Data* tables:

- Performance ratings are based on 80°F DB / 67°F WB EAT for cooling and 70°F DB EAT for heating.
- Three flow rates are shown for each unit. The lowest flow rate shown is used for geothermal open loop/well water systems with a minimum of 50°F EWT. The middle flow rate shown is the minimum geothermal closed loop flow rate. The highest flow rate shown is optimum for geothermal closed loop systems and the suggested flow rate for boiler/tower applications.
- The hot water generator numbers are based on a flow rate of 0.4 GPM/ton of rated capacity with an EWT of 90°F.
- Entering water temperatures below 40°F assumes 15% antifreeze solution.
- For non-standard EAT conditions, apply the appropriate *Correction Factors* table(s).
- Interpolation between EWT, GPM and CFM data is permissible, extrapolation is not.
- Pumping power is not included in the Performance Data tables nor are calculations for AHRI/ISO 13256-1.

Operating Limits

Operating Limits	Cooling		Heating	
	(°F)	(°C)	(°F)	(°C)
Air Limits				
Min. Ambient Air	45	7.2	45	7.2
Rated Ambient Air	80	26.7	70	21.1
Max. Ambient Air	100	37.8	85	29.4
Min. Entering Air	50	10.0	40	4.4
Rated Entering Air db/wb	80.6/66.2	27/19	68	20.0
Max. Entering Air db/wb	110/83	43/28.3	80	26.7
Water Limits				
Min. Entering Water	30	-1.1	20	-6.7
Normal Entering Water	50-110	10-43.3	30-70	-1.1
Max. Entering Water	120	48.9	90	32.2

NOTE: Minimum/maximum limits are only for start-up conditions, and are meant for bringing the space up to occupancy temperature. Units are not designed to operate at the minimum/maximum conditions on a regular basis. The operating limits are dependant upon three primary factors: 1) water temperature, 2) return air temperature, and 3) ambient temperature. When any of the factors are at the minimum or maximum levels, the other two factors must be at the normal level for proper and reliable unit operation.

Antifreeze Corrections

Catalog performance can be corrected for antifreeze use. Please use the following table and note the example given.

Antifreeze Type	Antifreeze % by wt	Heating	Cooling	Pressure Drop
EWT - °F [°C]		30 [-1.1]	90 [32.2]	30 [-1.1]
Water	0	1.000	1.000	1.000
Ethylene Glycol	10	0.973	0.991	1.075
	20	0.943	0.979	1.163
	30	0.917	0.965	1.225
	40	0.890	0.955	1.324
	50	0.865	0.943	1.419
Propylene Glycol	10	0.958	0.981	1.130
	20	0.913	0.969	1.270
	30	0.854	0.950	1.433
	40	0.813	0.937	1.614
	50	0.770	0.922	1.816
Ethanol	10	0.927	0.991	1.242
	20	0.887	0.972	1.343
	30	0.856	0.947	1.383
	40	0.815	0.930	1.523
	50	0.779	0.911	1.639
Methanol	10	0.957	0.986	1.127
	20	0.924	0.970	1.197
	30	0.895	0.951	1.235
	40	0.863	0.936	1.323
	50	0.833	0.920	1.399



WARNING: Gray area represents antifreeze concentrations greater than 35% by weight and should be avoided due to the extreme performance penalty they represent.

Antifreeze Correction Example

Antifreeze solution is Propylene Glycol 20% by weight. Determine the corrected heating and cooling performance at 30°F and 90°F respectively as well as pressure drop at 30°F for a Synergy3D Model O38.

The corrected cooling capacity at 90°F would be: 36,800 MBtu/h x 0.969 = 35,659 MBtu/h

The corrected heating capacity at 30°F would be: 26,600 MBtu/h x 0.913 = 24,286 MBtu/h

The corrected pressure drop at 30°F and 9 gpm would be: 7.9 feet of head x 1.270 = 10.03 feet of head

Correction Factor Tables

Air Flow Corrections (Dual Capacity Part Load)

Airflow		Cooling				Heating		
CFM Per Ton of Clg	% of Nominal	Total Cap	Sens Cap	Power	Heat of Rej	Htg Cap	Power	Heat of Ext
240	60	0.922	0.778	0.956	0.924	0.943	1.239	0.879
275	69	0.944	0.830	0.962	0.944	0.958	1.161	0.914
300	75	0.957	0.866	0.968	0.958	0.968	1.115	0.937
325	81	0.970	0.900	0.974	0.970	0.977	1.075	0.956
350	88	0.982	0.933	0.981	0.980	0.985	1.042	0.972
375	94	0.991	0.968	0.991	0.991	0.993	1.018	0.988
400	100	1.000	1.000	1.000	1.000	1.000	1.000	1.000
425	106	1.007	1.033	1.011	1.008	1.007	0.990	1.010
450	113	1.013	1.065	1.023	1.015	1.012	0.987	1.018
475	119	1.017	1.099	1.037	1.022	1.018	0.984	1.025
500	125	1.020	1.132	1.052	1.027	1.022	0.982	1.031
520	130	1.022	1.159	1.064	1.030	1.025	0.979	1.034

5/30/06

Air Flow Corrections (Dual Capacity Full Load & Single Speed)

Airflow		Cooling				Heating		
CFM Per Ton of Clg	% of Nominal	Total Cap	Sens Cap	Power	Heat of Rej	Htg Cap	Power	Heat of Ext
240	60	0.922	0.786	0.910	0.920	0.943	1.150	0.893
275	69	0.944	0.827	0.924	0.940	0.958	1.105	0.922
300	75	0.959	0.860	0.937	0.955	0.968	1.078	0.942
325	81	0.971	0.894	0.950	0.967	0.977	1.053	0.959
350	88	0.982	0.929	0.964	0.978	0.985	1.031	0.973
375	94	0.992	0.965	0.982	0.990	0.993	1.014	0.988
400	100	1.000	1.000	1.000	1.000	1.000	1.000	1.000
425	106	1.007	1.034	1.020	1.010	1.007	0.990	1.011
450	113	1.012	1.065	1.042	1.018	1.013	0.983	1.020
475	119	1.017	1.093	1.066	1.026	1.018	0.980	1.028
500	125	1.019	1.117	1.092	1.033	1.023	0.978	1.034
520	130	1.020	1.132	1.113	1.038	1.026	0.975	1.038

5/30/06

Cooling Capacity Corrections

Entering Air WB °F	Total Clg Cap	Sensible Cooling Capacity Multipliers - Entering DB °F										Power Input	Heat of Rejection
		60	65	70	75	80	80.6	85	90	95	100		
55	0.898	0.723	0.866	1.048	1.185	*	*	*	*	*	*	0.985	0.913
60	0.912		0.632	0.880	1.078	1.244	1.260	*	*	*	*	0.994	0.927
63	0.945			0.768	0.960	1.150	1.175	*	*	*	*	0.996	0.954
65	0.976			0.694	0.881	1.079	1.085	1.270	*	*	*	0.997	0.972
66.2	0.983			0.655	0.842	1.040	1.060	1.232	*	*	*	0.999	0.986
67	1.000			0.616	0.806	1.000	1.023	1.193	1.330	1.480	*	1.000	1.000
70	1.053				0.693	0.879	0.900	1.075	1.250	1.404	*	1.003	1.044
75	1.168					0.687	0.715	0.875	1.040	1.261	1.476	1.007	1.141

NOTE: *Sensible capacity equals total capacity at conditions shown.

03/28/12

Heating Capacity Corrections

Ent Air DB °F	Heating Corrections		
	Htg Cap	Power	Heat of Ext
45	1.062	0.739	1.158
50	1.050	0.790	1.130
55	1.037	0.842	1.096
60	1.025	0.893	1.064
65	1.012	0.945	1.030
68	1.005	0.976	1.012
70	1.000	1.000	1.000
75	0.987	1.048	0.970
80	0.975	1.099	0.930

11/10/09

Pressure Drop

Model	gpm	Pressure Drop (psi)				
		30°F	50°F	70°F	90°F	110°F
038 full load	5	1.2	1.2	1.1	1.0	1.0
	7	2.2	2.1	1.9	1.8	1.7
	9	3.4	3.2	3.0	2.8	2.6
	11	4.9	4.6	4.3	4.0	3.7
038 part load	4	0.9	0.8	0.8	0.7	0.7
	6	1.7	1.6	1.5	1.4	1.3
	8	2.8	2.6	2.5	2.3	2.1
	10	4.2	3.9	3.7	3.4	3.2
049 full load	6	1.2	1.2	1.1	1.0	1.0
	9	2.4	2.2	2.1	2.0	1.8
	12	3.9	3.6	3.4	3.2	2.9
	15	5.7	5.3	5.0	4.7	4.3
049 part load	5	1.1	1.1	1.0	0.9	0.9
	8	2.0	1.8	1.7	1.6	1.5
	11	3.4	3.1	2.9	2.8	2.5
	14	5.0	4.7	4.4	4.1	3.8
064 full load	8	2.0	1.8	1.7	1.6	1.5
	12	3.6	3.3	3.2	3.0	2.6
	16	6.5	6.0	5.6	5.2	4.8
	20	9.7	9.1	8.5	8.0	7.4
064 part load	6	1.2	1.2	1.1	1.0	1.0
	10	2.6	2.5	2.3	2.1	2.0
	14	5.0	4.7	4.4	4.1	3.8
	18	8.1	7.6	7.1	6.6	6.1
072 full load	12	3.6	3.3	3.2	3.0	2.6
	15	5.7	5.3	5.0	4.7	4.3
	18	8.1	7.6	7.1	6.6	6.1
	21	10.8	10.1	9.5	8.9	8.2
072 part load	10	2.6	2.5	2.3	2.1	2.0
	13	4.1	4.0	3.7	3.4	3.3
	16	6.5	6.0	5.8	5.4	5.0
	19	8.9	8.4	7.9	7.4	6.9

6/8/11

SDV038 Low Speed - Performance Data

EWT °F	Flow gpm	WPD		HEATING - EAT 70°F							COOLING - EAT 80/67 °F							
		PSI	FT	Airflow cfm	HC MBtu/h	Power kW	HE MBtu/h	LAT °F	COP	HWC MBtu/h	Airflow cfm	TC MBtu/h	SC MBtu/h	S/T Ratio	Power kW	HR MBtu/h	EER	HWC MBtu/h
20	4.0	0.9	2.2	Operation not recommended							Operation not recommended							
	6.0	1.8	4.1	Operation not recommended							Operation not recommended							
	8.0	2.9	6.8	900	15.1	1.60	9.6	85.5	2.75	2.4	Operation not recommended							
				1050	15.7	1.65	10.1	83.8	2.80	2.2	Operation not recommended							
30	4.0	0.9	2.1	Operation not recommended							Operation not recommended							
	6.0	1.7	3.9	900	16.8	1.58	11.4	87.3	3.12	2.3	900	25.8	15.6	0.60	0.92	29.0	28.0	-
				1050	17.5	1.62	12.0	85.4	3.17	2.1	1050	26.3	17.0	0.65	0.97	29.6	27.0	-
	8.0	2.8	6.6	900	17.9	1.62	12.3	88.4	3.24	2.4	900	26.0	15.6	0.60	0.90	29.0	29.0	-
1050				18.6	1.66	12.9	86.4	3.29	2.2	1050	26.6	17.0	0.64	0.94	29.8	28.3	-	
40	4.0	0.9	2.0	Operation not recommended							Operation not recommended							
	6.0	1.7	3.8	900	20.4	1.59	14.9	91.0	3.76	2.5	900	28.2	17.0	0.60	1.03	31.7	27.4	-
				1050	21.1	1.62	15.5	88.6	3.81	2.3	1050	28.7	18.6	0.65	1.08	32.4	26.6	-
	8.0	2.8	6.4	900	21.5	1.63	15.9	92.1	3.87	2.6	900	28.4	17.0	0.60	1.00	31.8	28.4	-
1050				22.2	1.66	16.5	89.6	3.92	2.4	1050	29.1	18.6	0.64	1.05	32.6	27.8	-	
50	4.0	0.9	2.0	900	23.1	1.60	17.7	93.8	4.24	2.6	900	29.9	17.6	0.59	1.17	33.9	25.6	0.9
				1050	23.8	1.62	18.3	91.0	4.31	2.4	1050	30.7	19.5	0.63	1.19	34.8	25.8	1.0
	6.0	1.6	3.7	900	23.9	1.60	18.5	94.6	4.38	2.7	900	30.2	17.7	0.59	1.14	34.0	26.5	0.9
				1050	24.7	1.62	19.1	91.7	4.46	2.5	1050	31.0	19.6	0.63	1.16	34.9	26.7	1.0
8.0	2.7	6.2	900	25.1	1.64	19.5	95.8	4.48	2.8	900	30.6	18.2	0.59	1.13	34.5	27.2	0.8	
			1050	25.8	1.66	20.1	92.8	4.56	2.5	1050	31.5	20.1	0.64	1.15	35.4	27.4	0.9	
60	4.0	0.8	1.9	900	26.7	1.65	21.1	97.5	4.75	2.9	900	28.8	18.4	0.64	1.31	33.2	22.1	1.3
				1050	27.4	1.66	21.7	94.1	4.83	2.6	1050	29.6	20.4	0.69	1.33	34.1	22.2	1.3
	6.0	1.6	3.6	900	27.8	1.65	22.2	98.6	4.95	3.0	900	29.1	18.5	0.64	1.27	33.4	22.8	1.2
				1050	28.4	1.66	22.8	95.1	5.03	2.7	1050	29.9	20.5	0.69	1.30	34.3	23.0	1.3
8.0	2.6	6.0	900	28.8	1.68	23.0	99.6	5.00	3.0	900	29.5	19.0	0.64	1.26	33.8	23.4	1.1	
			1050	29.4	1.69	23.6	95.9	5.09	2.8	1050	30.4	21.1	0.69	1.29	34.7	23.6	1.2	
70	4.0	0.8	1.8	900	30.3	1.70	24.5	101.2	5.22	3.2	900	27.7	19.3	0.70	1.44	32.6	19.2	1.7
				1050	30.9	1.70	25.1	97.2	5.32	2.9	1050	28.5	21.3	0.75	1.47	33.5	19.4	1.8
	6.0	1.5	3.5	900	31.6	1.69	25.8	102.5	5.47	3.3	900	28.0	19.4	0.69	1.41	32.7	19.9	1.6
				1050	32.2	1.69	26.4	98.4	5.58	3.0	1050	28.7	21.5	0.75	1.43	33.6	20.1	1.8
8.0	2.5	5.8	900	32.4	1.73	26.5	103.4	5.50	3.4	900	28.4	19.9	0.70	1.39	33.2	20.4	1.5	
			1050	33.0	1.73	27.1	99.1	5.60	3.1	1050	29.2	22.0	0.75	1.42	34.0	20.6	1.7	
80	4.0	0.8	1.8	900	33.4	1.73	27.5	104.4	5.65	3.6	900	26.4	19.0	0.72	1.63	31.9	16.2	2.4
				1050	33.9	1.72	28.0	99.9	5.76	3.3	1050	27.1	21.1	0.78	1.66	32.8	16.3	2.6
	6.0	1.4	3.3	900	35.0	1.72	29.2	106.1	5.96	3.7	900	26.6	19.2	0.72	1.59	32.0	16.8	2.3
				1050	35.5	1.71	29.6	101.3	6.07	3.4	1050	27.3	21.2	0.78	1.62	32.9	16.9	2.5
8.0	2.4	5.6	900	35.5	1.76	29.5	106.6	5.92	3.8	900	27.0	19.7	0.73	1.57	32.4	17.2	2.1	
			1050	35.9	1.74	30.0	101.7	6.03	3.5	1050	27.8	21.8	0.78	1.61	33.3	17.3	2.3	
90	4.0	0.7	1.7	900	36.6	1.77	30.5	107.6	6.06	4.0	900	25.0	18.8	0.75	1.82	31.2	13.8	3.2
				1050	36.9	1.75	30.9	102.5	6.18	3.7	1050	25.7	20.8	0.81	1.85	32.1	13.9	3.4
	6.0	1.4	3.2	900	38.5	1.75	32.5	109.6	6.42	4.2	900	25.3	18.9	0.75	1.77	31.3	14.3	3.0
				1050	38.7	1.73	32.8	104.1	6.56	3.8	1050	26.0	21.0	0.81	1.81	32.1	14.4	3.3
8.0	2.3	5.4	900	38.6	1.79	32.5	109.7	6.33	4.3	900	25.7	19.4	0.76	1.76	31.7	14.6	2.8	
			1050	38.8	1.76	32.8	104.2	6.46	4.0	1050	26.4	21.5	0.81	1.79	32.5	14.7	3.1	
100	4.0	0.7	1.7	Operation not recommended							Operation not recommended							
	6.0	1.3	3.1	900	23.6	1.83	0.78	2.00	30.5	11.8	3.9	Operation not recommended						
				1050	24.3	20.3	0.83	2.04	31.3	11.9	4.2	Operation not recommended						
	8.0	2.2	5.2	900	24.0	18.8	0.78	1.99	30.8	12.1	3.6	Operation not recommended						
1050				24.7	20.8	0.84	2.03	31.6	12.2	4.0	Operation not recommended							
110	4.0	0.7	1.6	Operation not recommended							Operation not recommended							
	6.0	1.3	3.0	900	22.0	17.7	0.80	2.24	29.6	9.8	5.0	Operation not recommended						
				1050	22.6	19.6	0.87	2.28	30.4	9.9	5.4	Operation not recommended						
	8.0	2.2	5.0	900	22.4	18.2	0.81	2.22	29.9	10.1	4.6	Operation not recommended						
1050				23.0	20.1	0.87	2.26	30.7	10.2	5.1	Operation not recommended							
120	4.0	0.7	1.5	Operation not recommended							Operation not recommended							
	6.0	1.2	2.9	900	20.4	17.8	0.87	2.55	29.1	8.0	5.9	Operation not recommended						
				1050	20.8	19.3	0.93	2.61	29.7	7.9	6.4	Operation not recommended						
	8.0	2.1	4.8	900	20.6	17.8	0.86	2.46	29.0	8.3	5.5	Operation not recommended						
1050				21.0	19.3	0.92	2.54	29.7	8.3	6.1	Operation not recommended							

Performance capacities shown in thousands of Btu/h.

11/11/13

IMPORTANT NOTE: Refer to Notes to Performance Tables for additional information.

SDV038 High Speed - Performance Data

EWT °F	Flow gpm	WPD		HEATING - EAT 70°F							COOLING - EAT 80/67 °F							
		PSI	FT	Airflow cfm	HC MBtu/h	Power kW	HE MBtu/h	LAT °F	COP	HWC MBtu/h	Airflow cfm	TC MBtu/h	SC MBtu/h	S/T Ratio	Power kW	HR MBtu/h	EER	HWC MBtu/h
20	5.0	1.3	3.0	Operation not recommended							Operation not recommended							
	7.0	2.2	5.1	Operation not recommended							Operation not recommended							
	9.0	3.5	8.1	1050	21.8	2.01	14.9	89.2	3.17	2.8	Operation not recommended							
30	5.0	1.2	2.9	Operation not recommended							Operation not recommended							
				1050	25.3	2.05	18.3	92.3	3.61	2.9	1050	38.4	23.3	0.61	1.59	43.8	24.1	-
	7.0	2.2	5.0	1250	26.1	2.12	18.9	89.3	3.61	2.7	1100	39.0	25.5	0.65	1.68	44.7	23.3	-
				1050	25.8	2.08	18.7	92.7	3.64	3.0	1050	38.6	23.3	0.61	1.54	43.8	25.0	-
40	5.0	1.2	2.8	Operation not recommended							Operation not recommended							
				1050	29.5	2.19	22.0	96.0	3.95	3.4	1050	40.6	25.4	0.63	1.76	46.6	23.0	-
	7.0	2.1	4.8	1250	30.4	2.24	22.8	92.5	3.99	3.1	1100	41.3	27.8	0.67	1.85	47.6	22.3	-
				1050	30.1	2.21	22.6	96.5	3.99	3.5	1050	40.9	25.4	0.62	1.71	46.7	23.9	-
50	5.0	1.2	2.7	1250	31.1	2.26	23.3	93.0	4.03	3.1	1100	41.8	27.8	0.66	1.79	47.9	23.4	-
				1050	32.5	2.27	24.7	98.6	4.19	3.6	1050	40.6	25.0	0.62	2.03	47.5	20.0	1.7
	7.0	2.0	4.7	1250	33.4	2.30	25.6	94.8	4.26	3.3	1100	42.7	27.8	0.65	2.14	50.0	20.0	1.8
				1050	33.7	2.32	25.7	99.7	4.25	3.7	1050	41.5	25.3	0.61	1.91	48.0	21.7	1.6
60	5.0	1.1	2.6	1250	34.4	2.34	26.4	100.4	4.30	3.8	1050	41.9	27.0	0.64	1.87	48.2	22.4	1.5
				1050	34.4	2.34	26.4	100.4	4.30	3.8	1100	44.1	30.0	0.68	1.96	50.8	22.5	1.7
	7.0	2.0	4.5	1250	35.5	2.38	27.4	96.3	4.38	3.5	1100	44.1	30.0	0.68	1.96	50.8	22.5	1.7
				1050	36.4	2.39	28.2	102.1	4.46	4.1	1050	39.1	24.9	0.64	2.19	46.6	17.9	2.1
70	5.0	1.1	2.5	1250	37.6	2.41	29.4	97.8	4.57	3.8	1100	41.0	27.7	0.67	2.29	48.8	18.0	2.2
				1050	38.0	2.46	29.6	103.5	4.53	4.2	1050	40.1	25.2	0.63	2.08	47.2	19.3	2.0
	7.0	1.9	4.4	1250	39.3	2.48	30.8	99.1	4.65	3.9	1100	42.0	27.9	0.67	2.17	49.4	19.4	2.1
				1050	39.0	2.49	30.5	104.4	4.59	4.3	1050	40.5	26.5	0.66	2.03	47.4	19.9	1.8
80	5.0	1.1	2.5	1250	40.3	2.50	31.7	99.8	4.72	4.0	1100	42.5	29.5	0.69	2.12	49.7	20.0	2.0
				1050	40.4	2.52	31.8	105.6	4.70	4.7	1050	37.7	24.8	0.66	2.35	45.7	16.1	2.6
	7.0	1.9	4.4	1250	41.7	2.52	33.2	100.9	4.86	4.3	1100	39.3	27.6	0.70	2.44	47.6	16.1	2.8
				1050	42.4	2.60	33.6	107.4	4.79	4.8	1050	38.7	25.1	0.65	2.25	46.3	17.2	2.4
90	5.0	1.1	2.5	1250	43.8	2.60	34.9	102.5	4.94	4.4	1100	40.3	27.8	0.69	2.32	48.2	17.3	2.6
				1050	43.5	2.63	34.5	108.4	4.85	5.0	1050	39.0	26.1	0.67	2.19	46.5	17.8	2.3
	7.0	1.8	4.2	1250	45.0	2.62	36.1	103.3	5.04	4.6	1100	40.8	28.9	0.71	2.28	48.6	17.9	2.5
				1050	43.4	2.65	34.4	108.3	4.79	5.2	1050	35.9	24.6	0.69	2.57	44.6	14.0	3.2
100	5.0	1.0	2.4	1250	44.9	2.63	35.9	103.3	5.00	4.8	1100	37.3	27.3	0.73	2.65	46.3	14.1	3.4
				1050	45.9	2.76	36.5	110.5	4.88	5.3	1050	36.9	24.9	0.67	2.48	45.3	14.9	3.0
	7.0	1.8	4.1	1250	47.5	2.73	38.2	105.2	5.09	4.9	1100	38.4	27.6	0.72	2.55	47.1	15.0	3.3
				1050	47.2	2.79	37.7	111.7	4.95	5.5	1050	37.3	25.5	0.68	2.43	45.5	15.4	2.8
110	5.0	1.0	2.2	1250	48.9	2.75	39.5	106.2	5.20	5.1	1100	38.8	28.3	0.73	2.50	47.3	15.5	3.1
				1050	46.5	2.79	36.9	111.0	4.88	5.9	1050	34.1	24.4	0.72	2.79	43.6	12.2	4.0
	7.0	1.6	3.8	1250	48.1	2.75	38.7	105.6	5.13	5.4	1100	35.3	27.1	0.77	2.86	45.0	12.4	4.3
				1050	49.4	2.92	39.4	113.6	4.96	6.0	1050	35.1	24.7	0.70	2.71	44.3	13.0	3.7
120	5.0	0.9	2.1	1250	51.1	2.87	41.4	107.9	5.23	5.6	1100	36.4	27.4	0.75	2.78	45.9	13.1	4.1
				1050	50.9	2.96	40.8	114.9	5.04	6.2	1050	35.5	24.9	0.70	2.66	44.6	13.3	3.5
	7.0	1.6	3.6	1250	52.7	2.89	42.8	109.0	5.35	5.8	1100	36.8	27.6	0.75	2.72	46.1	13.5	3.9
				1050	33.3	24.2	0.73	2.96	43.4	11.2	4.6	Operation not recommended						
110	5.0	1.0	2.2	Operation not recommended							Operation not recommended							
				1100	34.4	26.9	0.78	3.01	44.6	11.4	5.0	Operation not recommended						
	7.0	1.6	3.8	1050	33.7	24.1	0.72	2.91	43.6	11.6	4.4	Operation not recommended						
				1100	34.8	26.7	0.77	2.96	44.8	11.8	4.8	Operation not recommended						
120	5.0	0.9	2.1	Operation not recommended							Operation not recommended							
				1050	31.5	23.7	0.75	3.21	42.5	9.8	5.6	Operation not recommended						
	7.0	1.6	3.6	1100	32.4	26.3	0.81	3.24	43.4	10.0	6.1	Operation not recommended						
				1050	31.8	23.4	0.73	3.16	42.6	10.1	5.2	Operation not recommended						
120	5.0	0.9	2.1	Operation not recommended							Operation not recommended							
				1100	32.7	25.8	0.79	3.19	43.6	10.3	5.8	Operation not recommended						
	7.0	1.6	3.6	1050	29.5	22.8	0.77	3.57	41.7	8.3	6.8	Operation not recommended						
				1100	30.0	24.8	0.83	3.66	42.5	8.2	7.4	Operation not recommended						
9.0	2.5	5.8	1050	29.8	22.8	0.77	3.45	41.5	8.6	6.3	Operation not recommended							
			1100	30.4	24.8	0.82	3.56	42.5	8.5	7.0	Operation not recommended							

Performance capacities shown in thousands of Btuh.

11/11/13

IMPORTANT NOTE: Refer to Notes to Performance Tables for additional information.

SDVO38 Water Heating Data

ELT	EST	LGPM	SOURCE 5.0 GPM							SWPD		HWC MBtuh	SOURCE 7.0 GPM							SWPD		HWC MBtuh	SOURCE 9.0 GPM							SWPD		HWC MBtuh
			LLT	HC	KW	HE	COP	LST	PSI	FT HD	LLT		HC	KW	HE	COP	LST	PSI	FT HD	LLT	HC		KW	HE	COP	LST	PSI	FT HD				
80	30	5.0	Operation Not Recommended																													
		7.0	88.0	25.8	1.99	19.0	3.8	22.2	1.1	2.5	2.8	88.2	26.5	2.00	19.7	3.9	23.8	2.3	5.2	2.8	88.4	27.1	2.01	20.3	4.0	25.4	3.4	7.9	2.9			
		9.0	85.7	25.8	1.96	19.1	3.9	22.1	1.1	2.5	2.6	85.9	26.4	1.97	19.7	3.9	23.7	2.3	5.2	2.7	86.0	27.1	1.97	20.3	4.0	25.3	3.4	7.9	2.8			
80	40	5.0	Operation Not Recommended																													
		7.0	89.5	30.5	2.06	23.5	4.3	30.3	1.1	2.5	3.1	89.7	31.4	2.07	24.3	4.4	32.3	2.2	5.1	3.2	90.0	32.2	2.08	25.1	4.5	34.4	3.3	7.7	3.3			
		9.0	86.8	30.6	2.03	23.7	4.4	30.2	1.1	2.5	3.0	87.0	31.4	2.04	24.4	4.5	32.3	2.2	5.1	3.1	87.1	32.2	2.04	25.2	4.6	34.4	3.3	7.7	3.1			
80	50	5.0	94.0	34.9	2.16	27.6	4.7	38.6	1.1	2.4	3.6	94.4	36.1	2.18	28.6	4.8	41.0	2.2	5.0	3.7	94.9	37.3	2.20	29.7	5.0	43.4	3.3	7.5	3.8			
		7.0	90.9	35.2	2.13	27.9	4.8	38.5	1.1	2.4	3.5	91.3	36.2	2.15	28.9	4.9	40.9	2.2	5.0	3.6	91.6	37.3	2.16	29.9	5.1	43.4	3.3	7.5	3.7			
		9.0	87.9	35.5	2.11	28.3	4.9	38.3	1.1	2.4	3.4	88.1	36.4	2.11	29.2	5.1	40.8	2.2	5.0	3.4	88.3	37.2	2.11	30.0	5.2	43.3	3.3	7.5	3.5			
80	60	5.0	95.8	39.5	2.23	31.9	5.2	46.9	1.0	2.4	4.1	96.3	40.9	2.26	33.2	5.3	49.6	2.1	4.9	4.2	96.9	42.3	2.29	34.5	5.4	52.3	3.2	7.3	4.3			
		7.0	92.4	39.9	2.21	32.4	5.3	46.7	1.0	2.4	4.0	92.8	41.1	2.22	33.5	5.4	49.5	2.1	4.9	4.1	93.2	42.3	2.23	34.7	5.6	52.3	3.2	7.3	4.1			
		9.0	89.0	40.4	2.19	32.9	5.4	46.4	1.0	2.4	3.8	89.2	41.3	2.18	33.9	5.5	49.3	2.1	4.9	3.9	89.4	42.3	2.18	34.9	5.7	52.2	3.2	7.3	4.0			
80	70	5.0	97.6	44.0	2.30	36.1	5.6	55.1	1.0	2.3	4.7	98.3	45.7	2.33	37.7	5.7	58.2	2.1	4.7	4.8	98.9	47.3	2.37	39.2	5.9	61.3	3.1	7.2	4.9			
		7.0	93.8	44.6	2.28	36.8	5.7	54.8	1.0	2.3	4.6	94.3	46.0	2.29	38.2	5.9	58.0	2.1	4.7	4.7	94.7	47.4	2.31	39.5	6.0	61.2	3.1	7.2	4.7			
		9.0	90.0	45.2	2.26	37.5	5.9	54.5	1.0	2.3	4.4	90.3	46.3	2.26	38.6	6.0	57.9	2.1	4.7	4.5	90.5	47.4	2.25	39.7	6.2	61.2	3.1	7.2	4.6			
100	30	5.0	Operation Not Recommended																													
		7.0	107.8	25.1	2.58	16.3	2.9	23.3	1.1	2.5	2.7	108.0	25.6	2.58	16.8	2.9	24.7	2.3	5.2	2.7	108.1	26.1	2.58	17.3	3.0	26.2	3.4	7.9	2.8			
		9.0	105.6	25.0	2.53	16.3	2.9	23.3	1.1	2.5	2.6	105.7	25.5	2.54	16.9	2.9	24.7	2.3	5.2	2.6	105.8	26.1	2.54	17.4	3.0	26.1	3.4	7.9	2.7			
100	40	5.0	Operation Not Recommended																													
		7.0	109.1	29.4	2.64	20.3	3.3	31.6	1.1	2.5	3.0	109.3	30.0	2.65	21.0	3.3	33.4	2.2	5.1	3.1	109.5	30.7	2.66	21.6	3.4	35.2	3.3	7.7	3.1			
		9.0	106.5	29.4	2.60	20.5	3.3	31.5	1.1	2.5	2.9	106.7	30.0	2.60	21.1	3.4	33.4	2.2	5.1	3.0	106.8	30.7	2.61	21.8	3.4	35.2	3.3	7.7	3.0			
100	50	5.0	113.4	33.5	2.75	24.1	3.6	40.1	1.1	2.4	3.5	113.7	34.4	2.77	24.9	3.6	42.2	2.2	5.0	3.5	114.1	35.2	2.78	25.7	3.7	44.3	3.3	7.5	3.6			
		7.0	110.5	33.6	2.71	24.4	3.6	39.9	1.1	2.4	3.4	110.7	34.4	2.72	25.2	3.7	42.1	2.2	5.0	3.4	111.0	35.2	2.73	25.9	3.8	44.2	3.3	7.5	3.5			
		9.0	107.5	33.8	2.67	24.7	3.7	39.8	1.1	2.4	3.2	107.7	34.5	2.67	25.4	3.8	42.0	2.2	5.0	3.3	107.8	35.2	2.67	26.1	3.9	44.2	3.3	7.5	3.3			
100	60	5.0	115.1	37.7	2.82	28.1	3.9	48.4	1.0	2.4	3.9	115.5	38.7	2.84	29.0	4.0	50.9	2.1	4.9	4.0	115.9	39.7	2.86	30.0	4.1	53.3	3.2	7.3	2.8			
		7.0	111.8	37.9	2.77	28.5	4.0	48.3	1.0	2.4	3.8	112.1	38.9	2.79	29.3	4.1	50.8	2.1	4.9	3.8	112.4	39.8	2.80	30.2	4.2	53.3	3.2	7.3	2.7			
		9.0	108.5	38.2	2.73	28.9	4.1	48.1	1.0	2.4	3.6	108.7	39.0	2.73	29.7	4.2	50.7	2.1	4.9	3.7	108.8	39.8	2.74	30.5	4.3	53.2	3.2	7.3	3.8			
100	70	5.0	116.7	41.8	2.88	32.0	4.3	56.8	1.0	2.3	4.5	117.2	43.1	2.91	33.1	4.3	59.6	2.1	4.7	4.6	117.7	44.3	2.94	34.2	4.4	62.4	3.1	7.2	4.6			
		7.0	113.1	42.2	2.84	32.5	4.4	56.6	1.0	2.3	4.3	113.4	43.3	2.85	33.5	4.4	59.5	2.1	4.7	4.4	113.8	44.3	2.87	34.5	4.5	62.3	3.1	7.2	4.4			
		9.0	109.5	42.6	2.80	33.0	4.5	56.4	1.0	2.3	4.1	109.7	43.5	2.80	33.9	4.6	59.3	2.1	4.7	4.2	109.9	44.4	2.80	34.8	4.6	62.3	3.1	7.2	4.3			
120	30	5.0	Operation Not Recommended																													
		7.0	127.6	24.3	3.17	13.5	2.3	24.4	1.1	2.5	2.6	127.7	24.7	3.16	13.9	2.3	25.6	2.3	5.2	2.6	127.8	25.1	3.16	14.3	2.3	26.7	3.4	7.9	2.7			
		9.0	125.4	24.2	3.11	13.6	2.3	24.4	1.1	2.5	2.5	125.5	24.6	3.11	14.0	2.3	25.5	2.3	5.2	2.5	125.6	25.1	3.12	14.4	2.4	26.7	3.4	7.9	2.6			
120	40	5.0	Operation Not Recommended																													
		7.0	128.8	28.2	3.23	17.2	2.6	32.9	1.1	2.5	2.9	128.9	28.7	3.23	17.7	2.6	34.4	2.2	5.1	2.9	129.1	29.2	3.23	18.1	2.6	36.0	3.3	7.7	3.0			
		9.0	126.3	28.1	3.17	17.3	2.6	32.9	1.1	2.5	2.8	126.4	28.6	3.17	17.8	2.6	34.4	2.2	5.1	2.8	126.5	29.2	3.18	18.3	2.7	35.9	3.3	7.7	2.9			
120	50	5.0	132.8	32.1	3.34	20.7	2.8	41.5	1.1	2.4	3.3	133.1	32.6	3.35	21.2	2.9	43.3	2.2	5.0	3.4	133.3	33.2	3.36	21.7	2.9	45.2	3.3	7.5	3.4			
		7.0	130.0	32.1	3.28	20.9	2.9	41.4	1.1	2.4	3.2	130.2	32.6	3.29	21.4	2.9	43.3	2.2	5.0	3.2	130.3	33.2	3.30	22.0	3.0	45.1	3.3	7.5	3.3			
		9.0	127.1	32.1	3.22	21.1	2.9	41.3	1.1	2.4	3.0	127.3	32.7	3.23	21.6	3.0	43.2	2.2	5.0	3.1	127.4	33.2	3.23	22.2	3.0	45.1	3.3	7.5	3.1			
120	60	5.0	134.4	35.9	3.40	24.3	3.1	50.0	1.0	2.4	3.8	134.6	36.5	3.42	24.9	3.1	52.1	2.1	4.9	3.8	134.9	37.2	3.43	25.5	3.2	54.3	3.2	7.3	2.6			
		7.0	131.2	36.0	3.34	24.6	3.2	49.9	1.0	2.4	3.6	131.4	36.6	3.35	25.2	3.2	52.0	2.1	4.9	3.6	131.6	37.3	3.36	25.8	3.2	54.3	3.2	7.3	2.5			
		9.0	128.0	36.0	3.28	24.8	3.2	49.8	1.0	2.4	3.4	128.1	36.7	3.29	25.5	3.3	51.9	2.1	4.9	3.5	128.3	37.3	3.29	26.1	3.3	54.2	3.2	7.3	3.5			
120	70	5.0	135.9	39.7	3.46	27.9	3.4	58.5	1.0	2.3	4.3	136.2	40.5	3.49	28.6	3.4	60.9	2.1	4.7	4.3	136.5	41.2	3.51	29.2	3.4	63.3	3.1	7.2	4.3			
		7.0	132.4	39.8	3.40	28.2	3.4	58.4	1.0	2.3	4.1	132.6	40.6	3.42	28.9	3.5	60.8	2.1	4.7	4.1	132.8	41.3	3.43	29.6	3.5	63.2	3.1	7.2	4.1			
		9.0	128.9	40.0	3.34	28.6	3.5	58.2	1.0	2.3	3.9	129.0	40.7	3.34	29.3	3.6	60.7	2.1	4.7	3.9	129.2	41.4	3.35	30.0	3.6	63.1	3.1	7.2	4.0			

* Water heating mode only allows high compressor capacity operation.

2/21/11

ELT = entering load fluid temperature to heat pump
 LLT = leaving load fluid temperature from heat pump
 LGPM = load flow in gallons per minute
 LWPD = load coax water pressure drop
 EST = entering source fluid temperature to heat pump
 LST = leaving source fluid temperature from heat pump
 HWC = hot water generator capacity

SWPD = source coax water pressure drop
 PSI = pressure drop in pounds per square inch
 FT HD = pressure drop in feet of head
 KW = kilowatts
 HE = heat extracted in Btuh
 HC = total heating capacity in Btuh
 COP = coefficient of performance [HC/(kW x 3.413)]

IMPORTANT NOTE: Refer to Notes to Performance Tables for additional information.

SDV049 Low Speed - Performance Data

EWT °F	Flow gpm	WPD		HEATING - EAT 70°F							COOLING - EAT 80/67 °F							
		PSI	FT	Airflow cfm	HC MBtu/h	Power kW	HE MBtu/h	LAT °F	COP	HWC MBtu/h	Airflow cfm	TC MBtu/h	SC MBtu/h	S/T Ratio	Power kW	HR MBtu/h	EER	HWC MBtu/h
20	5.0	1.2	2.7	Operation not recommended							Operation not recommended							
	8.0	2.0	4.6	Operation not recommended							Operation not recommended							
	11.0	3.4	7.8	1150	22.0	2.06	15.0	87.7	3.13	4.1	Operation not recommended							
1350				22.8	2.09	15.7	85.6	3.20	3.7	Operation not recommended								
30	5.0	1.1	2.6	Operation not recommended							Operation not recommended							
	8.0	1.9	4.5	1150	25.2	2.18	17.8	90.3	3.40	4.2	1150	34.8	22.3	0.64	1.22	38.9	28.6	-
				1350	26.0	2.19	18.5	87.8	3.48	3.8	1350	35.3	24.4	0.69	1.28	39.7	27.5	-
	11.0	3.3	7.6	1150	25.9	2.19	18.4	90.8	3.46	4.3	1150	34.9	22.3	0.64	1.18	39.0	29.6	-
1350				26.8	2.23	19.2	88.4	3.53	3.9	1350	35.8	24.4	0.68	1.24	40.0	28.9	-	
40	5.0	1.1	2.5	Operation not recommended							Operation not recommended							
	8.0	1.9	4.3	1150	29.2	2.24	21.6	93.5	3.81	4.5	1150	37.6	25.6	0.68	1.37	42.3	27.3	-
				1350	30.2	2.24	22.6	90.7	3.95	4.2	1350	38.3	27.9	0.73	1.44	43.2	26.5	-
	11.0	3.2	7.4	1150	30.2	2.26	22.5	94.3	3.91	4.7	1150	37.9	25.6	0.68	1.33	42.4	28.4	-
1350				31.2	2.27	23.4	91.4	4.02	4.2	1350	38.7	27.9	0.72	1.40	43.5	27.7	-	
50	5.0	1.1	2.5	1150	30.8	2.24	23.2	94.8	4.04	4.8	1150	39.3	26.5	0.68	1.81	45.5	21.7	1.6
				1350	31.8	2.24	24.2	91.8	4.17	4.4	1350	40.5	31.3	0.77	1.88	46.9	21.5	1.7
	8.0	1.8	4.2	1150	33.2	2.31	25.3	96.7	4.21	4.9	1150	40.1	26.7	0.66	1.57	45.5	25.6	1.5
				1350	34.5	2.29	26.6	93.6	4.40	4.5	1350	41.4	31.4	0.76	1.64	47.0	25.2	1.6
	11.0	3.1	7.2	1150	34.5	2.32	26.5	97.8	4.35	5.1	1150	40.4	26.7	0.66	1.47	45.4	27.4	1.4
				1350	35.6	2.32	27.7	94.4	4.49	4.6	1350	41.6	31.4	0.75	1.55	46.9	26.8	1.5
60	5.0	1.0	2.4	1150	34.2	2.32	26.3	97.5	4.31	5.2	1150	37.7	26.0	0.69	1.98	44.5	19.0	2.3
				1350	35.4	2.31	27.6	94.3	4.50	4.8	1350	38.9	30.6	0.79	2.07	46.0	18.8	2.4
	8.0	1.8	4.1	1150	37.0	2.38	28.9	99.8	4.55	5.4	1150	38.3	26.2	0.68	1.76	44.3	21.8	2.1
				1350	38.4	2.35	30.4	96.4	4.79	5.0	1350	39.5	30.8	0.78	1.84	45.8	21.5	2.3
	11.0	3.0	6.9	1150	38.6	2.40	30.4	101.1	4.71	5.5	1150	38.8	26.3	0.68	1.67	44.5	23.2	1.9
				1350	40.0	2.37	31.8	97.4	4.93	5.1	1350	40.0	30.9	0.77	1.75	45.9	22.9	2.2
70	5.0	1.0	2.3	1150	37.6	2.41	29.4	100.3	4.57	5.8	1150	36.2	25.5	0.71	2.16	43.5	16.8	3.0
				1350	39.1	2.38	31.0	96.8	4.81	5.4	1350	37.3	30.0	0.80	2.26	45.0	16.5	3.1
	8.0	1.7	3.9	1150	40.8	2.45	32.5	102.9	4.88	6.0	1150	36.5	25.8	0.70	1.95	43.2	18.7	2.8
				1350	42.4	2.41	34.2	99.1	5.16	5.5	1350	37.7	30.3	0.80	2.04	44.6	18.5	3.0
	11.0	2.9	6.7	1150	42.7	2.48	34.2	104.4	5.04	6.1	1150	37.2	25.9	0.70	1.87	43.5	19.9	2.6
				1350	44.3	2.43	36.0	100.4	5.35	5.7	1350	38.3	30.4	0.79	1.94	44.9	19.7	2.8
80	5.0	1.0	2.2	1150	40.0	2.47	31.6	102.2	4.75	6.5	1150	34.5	24.8	0.72	2.36	42.6	14.6	4.2
				1350	41.6	2.43	33.3	98.5	5.02	6.0	1350	35.6	29.2	0.82	2.46	44.0	14.5	4.4
	8.0	1.6	3.8	1150	43.5	2.50	34.9	105.0	5.10	6.7	1150	34.7	25.1	0.72	2.19	42.2	15.8	3.9
				1350	45.2	2.44	36.9	101.0	5.44	6.1	1350	35.8	29.5	0.83	2.28	43.5	15.7	4.2
	11.0	2.8	6.5	1150	45.7	2.53	37.1	106.8	5.30	6.9	1150	35.5	25.3	0.71	2.10	42.7	16.9	3.6
				1350	47.5	2.46	39.1	102.6	5.66	6.3	1350	36.6	29.8	0.81	2.19	44.1	16.8	4.0
90	5.0	0.9	2.2	1150	42.4	2.53	33.8	104.2	4.91	7.2	1150	32.9	24.2	0.73	2.56	41.7	12.9	5.4
				1350	44.1	2.48	35.6	100.2	5.22	6.7	1350	34.0	28.4	0.84	2.67	43.1	12.7	5.7
	8.0	1.6	3.7	1150	46.1	2.55	37.4	107.1	5.31	7.4	1150	32.9	24.5	0.74	2.43	41.2	13.6	5.0
				1350	48.0	2.46	39.6	102.9	5.72	6.9	1350	33.9	28.8	0.85	2.52	42.4	13.4	5.5
	11.0	2.7	6.2	1150	48.7	2.57	39.9	109.2	5.54	7.7	1150	33.9	24.7	0.73	2.33	41.8	14.5	4.7
				1350	50.7	2.49	42.2	104.8	5.97	7.1	1350	34.9	29.1	0.83	2.43	43.2	14.4	5.2
100	5.0	0.9	2.1	Operation not recommended							Operation not recommended							
	8.0	1.5	3.5	1150	30.6	23.7	0.78	2.73	39.9	11.2	3.6	Operation not recommended						
				1350	31.5	28.0	0.89	2.84	41.2	11.1	3.9	Operation not recommended						
	11.0	2.6	6.0	1150	31.7	24.1	0.76	2.63	40.7	12.1	3.3	Operation not recommended						
1350				32.7	28.3	0.87	2.75	42.0	11.9	3.7	Operation not recommended							
110	5.0	0.9	2.0	Operation not recommended							Operation not recommended							
	8.0	1.5	3.4	1150	28.2	23.0	0.82	3.03	38.6	9.3	4.4	Operation not recommended						
				1350	29.2	27.1	0.93	3.15	39.9	9.3	4.7	Operation not recommended						
	11.0	2.5	5.8	1150	29.6	23.4	0.79	2.93	39.6	10.1	4.1	Operation not recommended						
1350				30.4	27.5	0.90	3.06	40.8	9.9	4.5	Operation not recommended							
120	5.0	0.8	1.9	Operation not recommended							Operation not recommended							
	8.0	1.4	3.3	1150	26.9	24.4	0.91	3.43	38.6	7.8	5.3	Operation not recommended						
				1350	27.4	26.5	0.97	3.52	39.4	7.8	5.7	Operation not recommended						
	11.0	2.4	5.6	1150	27.1	24.4	0.90	3.32	38.4	8.2	4.9	Operation not recommended						
1350				27.7	26.5	0.96	3.42	39.4	8.1	5.4	Operation not recommended							

Performance capacities shown in thousands of Btuh.

11/11/13

IMPORTANT NOTE: Refer to Notes to Performance Tables for additional information.

SDVO49 High Speed - Performance Data

EWT °F	Flow gpm	WPD		HEATING - EAT 70°F							COOLING - EAT 80/67 °F							
		PSI	FT	Airflow cfm	HC MBtu/h	Power kW	HE MBtu/h	LAT °F	COP	HWC MBtu/h	Airflow cfm	TC MBtu/h	SC MBtu/h	S/T Ratio	Power kW	HR MBtu/h	EER	HWC MBtu/h
20	6.0	1.3	3.0	Operation not recommended							Operation not recommended							
	9.0	2.5	5.7	Operation not recommended							Operation not recommended							
	12.0	4.0	9.2	1350	27.4	2.57	18.6	88.8	3.12	4.7	Operation not recommended							
				1550	28.4	2.61	19.5	87.0	3.19	4.2	Operation not recommended							
30	6.0	1.2	2.9	Operation not recommended							Operation not recommended							
	9.0	2.4	5.5	1350	30.6	2.54	21.9	91.0	3.53	4.9	1350	41.5	26.7	0.64	1.75	47.4	23.7	-
				1550	31.6	2.56	22.8	88.9	3.61	4.5	1550	42.1	29.2	0.69	1.84	48.4	22.9	-
				1350	31.4	2.56	22.6	91.5	3.59	5.0	1350	41.7	26.7	0.64	1.70	47.5	24.6	-
				1550	32.5	2.60	23.6	89.4	3.67	4.6	1550	42.7	29.2	0.68	1.78	48.8	24.0	-
12.0	3.9	8.9	Operation not recommended							Operation not recommended								
40	6.0	1.2	2.8	Operation not recommended							Operation not recommended							
	9.0	2.3	5.3	1350	35.5	2.71	26.2	94.3	3.84	5.6	1350	44.2	30.6	0.69	1.95	50.8	22.7	-
				1550	36.7	2.71	27.5	91.9	3.97	5.2	1550	45.0	33.5	0.74	2.04	52.0	22.0	-
				1350	36.6	2.73	27.3	95.1	3.94	5.8	1350	44.5	30.6	0.69	1.89	50.9	23.6	-
				1550	37.9	2.75	28.5	92.6	4.04	5.3	1550	45.5	33.5	0.74	1.98	52.2	23.0	-
12.0	3.7	8.7	Operation not recommended							Operation not recommended								
50	6.0	1.2	2.7	1350	37.5	2.79	28.0	95.7	3.94	6.1	1350	45.6	31.8	0.70	2.53	54.2	18.0	2.7
				1550	38.7	2.79	29.2	93.1	4.07	5.6	1550	47.0	37.5	0.80	2.64	56.0	17.8	2.9
	9.0	2.2	5.2	1350	40.4	2.88	30.6	97.7	4.11	6.3	1350	46.6	32.0	0.69	2.19	54.1	21.3	2.5
				1550	41.9	2.86	32.2	95.0	4.30	5.8	1550	48.0	37.7	0.79	2.30	55.9	20.9	2.7
				1350	41.9	2.90	32.0	98.8	4.24	6.5	1350	46.9	32.0	0.68	2.06	53.9	22.7	2.3
				1550	43.3	2.90	33.4	95.9	4.38	5.9	1550	48.3	37.7	0.78	2.17	55.7	22.3	2.6
12.0	3.6	8.4	Operation not recommended							Operation not recommended								
60	6.0	1.1	2.6	1350	41.4	2.92	31.4	98.4	4.15	6.9	1350	44.2	31.6	0.72	2.70	53.4	16.4	3.2
				1550	42.8	2.90	32.9	95.6	4.33	6.4	1550	45.6	37.3	0.82	2.82	55.2	16.2	3.4
	9.0	2.2	5.0	1350	44.7	2.99	34.5	100.7	4.38	7.1	1350	44.9	31.9	0.71	2.40	53.1	18.8	3.0
				1550	46.5	2.96	36.4	97.8	4.61	6.6	1550	46.3	37.5	0.81	2.51	54.8	18.5	3.2
				1350	46.6	3.02	36.3	102.0	4.53	7.3	1350	45.4	32.0	0.70	2.27	53.2	20.0	2.7
				1550	48.3	2.98	38.1	98.9	4.74	6.7	1550	46.8	37.6	0.80	2.38	54.9	19.7	3.1
12.0	3.5	8.1	Operation not recommended							Operation not recommended								
70	6.0	1.1	2.5	1350	45.3	3.05	34.9	101.1	4.34	7.9	1350	42.8	31.4	0.74	2.87	52.5	14.9	3.9
				1550	47.0	3.02	36.7	98.1	4.57	7.3	1550	44.1	37.0	0.84	3.00	54.4	14.7	4.2
	9.0	2.1	4.9	1350	49.1	3.11	38.5	103.7	4.63	8.1	1350	43.2	31.8	0.74	2.60	52.1	16.6	3.7
				1550	51.1	3.05	40.6	100.5	4.90	7.5	1550	44.6	37.3	0.84	2.71	53.8	16.4	4.0
				1350	51.4	3.14	40.6	105.2	4.79	8.4	1350	44.0	31.9	0.73	2.48	52.4	17.7	3.4
				1550	53.3	3.07	42.8	101.8	5.09	7.7	1550	45.3	37.5	0.83	2.58	54.1	17.6	3.8
12.0	3.4	7.9	Operation not recommended							Operation not recommended								
80	6.0	1.1	2.5	1350	47.4	3.16	36.6	102.5	4.40	8.7	1350	41.0	29.8	0.73	2.97	51.1	13.8	5.1
				1550	49.2	3.10	38.6	99.4	4.65	8.1	1550	42.3	35.0	0.83	3.09	52.8	13.7	5.4
	9.0	2.0	4.7	1350	51.5	3.19	40.6	105.3	4.72	9.0	1350	41.2	30.1	0.73	2.75	50.6	15.0	4.7
				1550	53.6	3.11	42.9	102.0	5.04	8.3	1550	42.4	35.4	0.83	2.86	52.2	14.8	5.1
				1350	54.1	3.23	43.1	107.1	4.91	9.3	1350	42.1	30.3	0.72	2.63	51.1	16.0	4.4
				1550	56.3	3.14	45.5	103.6	5.25	8.6	1550	43.4	35.6	0.82	2.75	52.8	15.8	4.9
12.0	3.3	7.6	Operation not recommended							Operation not recommended								
90	6.0	1.0	2.4	1350	49.5	3.26	38.4	104.0	4.45	9.7	1350	39.2	28.1	0.72	3.07	49.6	12.8	6.3
				1550	51.5	3.19	40.6	100.7	4.73	9.0	1550	40.4	33.0	0.82	3.19	51.3	12.7	6.7
	9.0	2.0	4.5	1350	53.8	3.28	42.7	106.9	4.81	10.0	1350	39.2	28.4	0.73	2.91	49.1	13.5	5.9
				1550	56.1	3.17	45.3	103.5	5.18	9.3	1550	40.3	33.5	0.83	3.02	50.5	13.3	6.4
				1350	56.8	3.31	45.5	109.0	5.03	10.3	1350	40.3	28.7	0.71	2.79	49.8	14.4	5.5
				1550	59.2	3.21	48.3	105.4	5.41	9.6	1550	41.5	33.8	0.81	2.91	51.4	14.3	6.1
12.0	3.2	7.3	Operation not recommended							Operation not recommended								
100	6.0	1.0	2.3	Operation not recommended							Operation not recommended							
	9.0	1.9	4.4	1350	36.8	2.76	27.6	87.5	3.31	48.1	11.1	7.5	Operation not recommended					
				1550	37.9	32.4	0.86	3.44	49.6	11.0	8.1	Operation not recommended						
				1350	38.1	28.0	0.73	3.19	49.0	12.0	7.0	Operation not recommended						
12.0	3.1	7.1	1550	39.3	32.8	0.84	3.33	50.6	11.8	7.7	Operation not recommended							
110	6.0	1.0	2.2	Operation not recommended							Operation not recommended							
	9.0	1.8	4.2	1350	34.4	26.7	0.78	3.71	47.1	9.3	9.3	Operation not recommended						
				1550	35.6	31.4	0.88	3.87	48.7	9.2	10.1	Operation not recommended						
				1350	36.0	27.2	0.75	3.60	48.3	10.0	8.7	Operation not recommended						
				1550	37.0	31.9	0.86	3.75	49.8	9.9	9.6	Operation not recommended						
12.0	2.9	6.8	Operation not recommended							Operation not recommended								
120	6.0	0.9	2.1	Operation not recommended							Operation not recommended							
	9.0	1.7	4.0	1350	33.1	28.5	0.86	4.15	47.2	8.0	11.3	Operation not recommended						
				1550	33.7	31.0	0.92	4.26	48.2	7.9	12.2	Operation not recommended						
				1350	33.4	28.5	0.85	4.01	47.1	8.3	10.5	Operation not recommended						
12.0	2.8	6.5	1550	34.1	31.0	0.91	4.14	48.2	8.2	11.6	Operation not recommended							

Performance capacities shown in thousands of Btuh.

11/11/13

IMPORTANT NOTE: Refer to Notes to Performance Tables for additional information.

SDV049 Water Heating Data

ELT	EST	LGPM	SOURCE 6.0 GPM								SWPD		HWC MBtuh	SOURCE 9.0 GPM								SWPD		HWC MBtuh	SOURCE 12.0 GPM								SWPD		HWC MBtuh
			LLT	HC	KW	HE	COP	LST	PSI	FT HD	LLT	HC		KW	HE	COP	LST	PSI	FT HD	LLT	HC	KW	HE		COP	LST	PSI	FT HD							
80	30	6.0	Operation Not Recommended																																
		9.0	88.0	32.1	2.54	23.5	3.7	21.9	1.2	2.8	4.6	88.3	33.1	2.56	24.4	3.8	23.8	2.7	6.2	4.7	88.5	34.0	2.57	25.2	3.9	25.7	4.2	9.7	4.8						
		12.0	85.3	32.1	2.49	23.6	3.8	21.9	1.2	2.8	4.4	85.5	33.0	2.50	24.5	3.9	23.8	2.7	6.2	4.5	85.7	33.9	2.51	25.4	4.0	25.6	4.2	9.7	4.6						
80	40	6.0	Operation Not Recommended																																
		9.0	89.3	37.0	2.58	28.2	4.2	30.3	1.2	2.7	5.3	89.6	38.2	2.59	29.4	4.3	32.6	2.6	6.1	5.4	89.9	39.4	2.60	30.5	4.4	34.9	4.1	9.4	5.5						
		12.0	86.2	37.0	2.52	28.4	4.3	30.2	1.2	2.7	5.1	86.4	38.2	2.52	29.6	4.4	32.5	2.6	6.1	5.2	86.6	39.4	2.53	30.7	4.6	34.9	4.1	9.4	5.3						
80	50	6.0	94.0	41.9	2.68	32.8	4.6	38.7	1.2	2.7	6.1	94.5	43.4	2.70	34.2	4.7	41.4	2.6	5.9	6.3	94.9	44.8	2.72	35.6	4.8	44.1	4.0	9.1	6.4						
		9.0	90.5	41.9	2.61	33.0	4.7	38.7	1.2	2.7	5.9	90.8	43.4	2.62	34.4	4.8	41.3	2.6	5.9	6.0	91.2	44.8	2.64	35.8	5.0	44.0	4.0	9.1	6.2						
		12.0	87.0	41.9	2.54	33.2	4.8	38.6	1.2	2.7	5.7	87.2	43.3	2.55	34.6	5.0	41.3	2.6	5.9	5.8	87.5	44.8	2.56	36.1	5.1	44.0	4.0	9.1	5.9						
80	60	6.0	95.6	46.8	2.72	37.5	5.0	47.1	1.1	2.6	7.0	96.2	48.5	2.74	39.2	5.2	50.2	2.5	5.7	7.1	96.7	50.2	2.76	40.8	5.3	53.2	3.8	8.8	7.3						
		9.0	91.7	46.8	2.64	37.8	5.2	47.0	1.1	2.6	6.7	92.1	48.5	2.66	39.4	5.3	50.1	2.5	5.7	6.9	92.6	50.2	2.67	41.1	5.5	53.1	3.8	8.8	7.0						
		12.0	87.8	46.8	2.56	38.0	5.3	46.9	1.1	2.6	6.5	88.1	48.5	2.57	39.7	5.5	50.0	2.5	5.7	6.6	88.4	50.2	2.58	41.4	5.7	53.1	3.8	8.8	6.7						
80	70	6.0	97.2	51.7	2.76	42.2	5.5	55.5	1.1	2.5	8.0	97.9	53.6	2.79	44.1	5.6	58.9	2.4	5.5	8.2	98.5	55.6	2.81	46.0	5.8	62.3	3.7	8.5	8.3						
		9.0	92.9	51.7	2.68	42.5	5.7	55.4	1.1	2.5	7.7	93.4	53.6	2.69	44.5	5.8	58.8	2.4	5.5	7.9	93.9	55.6	2.70	46.4	6.0	62.3	3.7	8.5	8.0						
		12.0	88.6	51.7	2.59	42.8	5.8	55.3	1.1	2.5	7.4	88.9	53.7	2.59	44.8	6.1	58.7	2.4	5.5	7.6	89.3	55.7	2.60	46.8	6.3	62.2	3.7	8.5	7.7						
100	30	6.0	Operation Not Recommended																																
		9.0	107.8	31.1	3.25	20.0	2.8	23.1	1.2	2.8	4.4	108.1	32.3	3.30	21.0	2.9	24.7	2.7	6.2	4.5	108.4	33.4	3.36	22.0	2.9	26.3	4.2	9.7	4.7						
		12.0	105.2	31.2	3.20	20.2	2.9	23.0	1.2	2.8	4.3	105.3	31.9	3.20	21.0	2.9	24.7	2.7	6.2	4.3	105.4	32.7	3.21	21.7	3.0	26.4	4.2	9.7	4.4						
100	40	6.0	Operation Not Recommended																																
		9.0	108.9	35.6	3.28	24.4	3.2	31.6	1.2	2.7	5.1	109.3	36.9	3.32	25.6	3.3	33.6	2.6	6.1	5.2	109.6	38.3	3.37	26.8	3.3	35.5	4.1	9.4	5.3						
		12.0	105.9	35.7	3.21	24.7	3.3	31.5	1.2	2.7	4.9	106.1	36.7	3.22	25.7	3.3	33.5	2.6	6.1	5.0	106.3	37.7	3.23	26.7	3.4	35.6	4.1	9.4	5.0						
100	50	6.0	113.4	40.1	3.39	28.5	3.5	40.2	1.2	2.7	5.9	113.9	41.7	3.45	30.0	3.5	42.5	2.6	5.9	6.0	114.5	43.4	3.51	31.4	3.6	44.8	4.0	9.1	6.2						
		9.0	110.0	40.1	3.31	28.9	3.6	40.1	1.2	2.7	5.7	110.4	41.6	3.34	30.2	3.6	42.4	2.6	5.9	5.8	110.8	43.1	3.38	31.5	3.7	44.7	4.0	9.1	5.9						
		12.0	106.7	40.2	3.23	29.2	3.6	40.0	1.2	2.7	5.5	106.9	41.5	3.24	30.4	3.8	42.3	2.6	5.9	5.5	107.1	42.7	3.25	31.6	3.9	44.7	4.0	9.1	5.6						
100	60	6.0	114.9	44.6	3.42	32.9	3.8	48.7	1.1	2.6	6.7	115.4	46.3	3.47	34.5	3.9	51.3	2.5	5.7	6.8	116.0	48.0	3.52	36.0	4.0	54.0	3.8	8.8	7.0						
		9.0	111.2	44.7	3.34	33.3	3.9	48.6	1.1	2.6	6.4	111.6	46.3	3.36	34.8	4.0	51.3	2.5	5.7	6.6	112.0	47.9	3.39	36.3	4.1	53.9	3.8	8.8	6.7						
		12.0	107.5	44.8	3.25	33.7	4.0	48.4	1.1	2.6	6.2	107.7	46.3	3.26	35.1	4.2	51.2	2.5	5.7	6.3	108.0	47.7	3.26	36.6	4.3	53.9	3.8	8.8	6.4						
100	70	6.0	116.4	49.1	3.46	37.3	4.2	57.2	1.1	2.5	7.6	117.0	50.9	3.49	38.9	4.3	60.2	2.4	5.5	7.7	117.5	52.6	3.53	40.6	4.4	63.2	3.7	8.5	7.9						
		9.0	112.3	49.2	3.36	37.7	4.3	57.0	1.1	2.5	7.3	112.7	50.9	3.38	39.4	4.4	60.1	2.4	5.5	7.5	113.2	52.7	3.40	41.1	4.5	63.2	3.7	8.5	7.6						
		12.0	108.2	49.3	3.27	38.2	4.4	56.9	1.1	2.5	7.1	108.5	51.0	3.27	39.9	4.6	60.0	2.4	5.5	7.2	108.8	52.8	3.28	41.6	4.7	63.1	3.7	8.5	7.3						
120	30	6.0	Operation Not Recommended																																
		9.0	127.5	30.0	3.96	16.5	2.2	24.3	1.2	2.8	4.3	127.9	31.5	4.05	17.6	2.3	25.6	2.7	6.2	4.4	128.3	32.9	4.14	18.7	2.3	26.8	4.2	9.7	4.6						
		12.0	125.0	30.2	3.90	16.9	2.3	24.2	1.2	2.8	4.1	125.1	30.8	3.91	17.5	2.3	25.5	2.7	6.2	4.2	125.2	31.4	3.91	18.0	2.3	26.9	4.2	9.7	4.2						
120	40	6.0	Operation Not Recommended																																
		9.0	128.5	34.2	3.99	20.6	2.5	32.9	1.2	2.7	4.9	128.9	35.7	4.06	21.8	2.6	34.5	2.6	6.1	5.0	129.4	37.1	4.13	23.0	2.6	36.2	4.1	9.4	5.2						
		12.0	125.7	34.4	3.91	21.1	2.6	32.8	1.2	2.7	4.7	125.9	35.2	3.92	21.8	2.6	34.5	2.6	6.1	4.8	126.0	36.0	3.92	22.6	2.7	36.2	4.1	9.4	4.8						
120	50	6.0	132.7	38.2	4.09	24.2	2.7	41.7	1.2	2.7	5.6	133.4	40.1	4.20	25.8	2.8	43.6	2.6	5.9	5.8	134.0	42.0	4.31	27.3	2.9	45.4	4.0	9.1	6.0						
		9.0	129.6	38.4	4.01	24.7	2.8	41.5	1.2	2.7	5.4	130.0	39.8	4.06	26.0	2.9	43.5	2.6	5.9	5.5	130.4	41.3	4.12	27.2	2.9	45.5	4.0	9.1	5.7						
		12.0	126.4	38.6	3.92	25.2	2.9	41.3	1.2	2.7	5.2	126.6	39.6	3.93	26.2	3.0	43.4	2.6	5.9	5.3	126.8	40.6	3.94	27.2	3.0	45.5	4.0	9.1	5.4						
120	60	6.0	134.1	42.4	4.13	28.3	3.0	50.3	1.1	2.6	6.3	134.7	44.1	4.20	29.8	3.1	52.5	2.5	5.7	6.5	135.3	45.8	4.28	31.2	3.1	54.8	3.8	8.8	6.6						
		9.0	130.6	42.6	4.03	28.8	3.1	50.1	1.1	2.6	6.1	131.0	44.0	4.07	30.2	3.2	52.4	2.5	5.7	6.2	131.4	45.5	4.11	31.5	3.2	54.7	3.8	8.8	6.3						
		12.0	127.1	42.8	3.93	29.4	3.2	49.9	1.1	2.6	5.9	127.3	44.0	3.94	30.6	3.3	52.3	2.5	5.7	6.0	127.5	45.2	3.95	31.8	3.4	54.7	3.8	8.8	6.1						
120	70	6.0	135.5	46.5	4.16	32.3	3.3	58.9	1.1	2.5	7.2	136.0	48.1	4.20	33.8	3.4	61.4	2.4	5.5	7.3	136.6	49.7	4.24	35.2	3.4	64.0	3.7	8.5	7.4						
		9.0	131.7	46.7	4.05	32.9	3.4	58.7	1.1	2.5	7.0	132.0	48.2	4.08	34.3	3.5	61.3	2.4	5.5	7.1	132.4	49.7	4.10	35.8	3.6	63.9	3.7	8.5	7.2						
		12.0	127.8	47.0	3.94	33.5	3.5	58.5	1.1	2.5	6.7	128.1	48.4	3.95	34.9	3.6	61.1	2.4	5.5	6.8	128.3	49.8	3.96	36.3	3.7	63.8	3.7	8.5	6.9						

* Water heating mode only allows high compressor capacity operation.

2/21/11

ELT = entering load fluid temperature to heat pump
 LLT = leaving load fluid temperature from heat pump
 LGPM = load flow in gallons per minute
 LWPD = load coax water pressure drop
 EST = entering source fluid temperature to heat pump
 LST = leaving source fluid temperature from heat pump
 HWC = hot water generator capacity

SWPD = source coax water pressure drop
 PSI = pressure drop in pounds per square inch
 FT HD = pressure drop in feet of head
 KW = kilowatts
 HE = heat extracted in Btuh
 HC = total heating capacity in Btuh
 COP = coefficient of performance [HC/(kW x 3.413)]

IMPORTANT NOTE: Refer to Notes to Performance Tables for additional information.

SDV064 Low Speed - Performance Data

EWT °F	Flow gpm	WPD		HEATING - EAT 70°F							COOLING - EAT 80/67 °F							
		PSI	FT	Airflow cfm	HC MBtu/h	Power kW	HE MBtu/h	LAT °F	COP	HWC MBtu/h	Airflow cfm	TC MBtu/h	SC MBtu/h	S/T Ratio	Power kW	HR MBtu/h	EER	HWC MBtu/h
20	6.0	1.3	3.0	Operation not recommended							Operation not recommended							
	10.0	2.7	6.2	Operation not recommended							Operation not recommended							
	14.0	5.1	11.9	1250	24.6	2.71	15.3	88.2	2.65	4.6	Operation not recommended							
				1500	25.4	2.75	16.0	85.7	2.71	4.2	Operation not recommended							
30	6.0	1.2	2.9	Operation not recommended							Operation not recommended							
	10.0	2.6	6.0	1250	28.1	2.77	18.6	90.8	2.97	4.6	1250	46.4	30.8	0.66	1.57	51.8	29.5	-
				1500	29.1	2.81	19.5	88.0	3.04	4.2	1500	47.2	33.7	0.71	1.66	52.8	28.5	-
				1250	29.1	2.77	19.6	91.6	3.08	4.7	1250	46.7	30.8	0.66	1.52	51.9	30.6	-
	14.0	5.0	11.6	1500	30.1	2.81	20.5	88.6	3.14	4.3	1500	47.8	33.7	0.70	1.60	53.3	29.9	-
40	6.0	1.2	2.8	Operation not recommended							Operation not recommended							
	10.0	2.5	5.9	1250	33.7	2.87	23.9	95.0	3.44	5.1	1250	49.1	32.9	0.67	1.79	55.2	27.4	-
				1500	34.7	2.88	24.8	91.4	3.52	4.6	1500	50.0	35.9	0.72	1.88	56.4	26.6	-
				1250	34.8	2.88	25.0	95.8	3.54	5.2	1250	49.4	32.9	0.67	1.74	55.4	28.4	-
	14.0	4.8	11.2	1500	35.8	2.89	25.9	92.1	3.62	4.8	1500	50.6	35.9	0.71	1.82	56.8	27.8	-
50	6.0	1.2	2.7	1250	38.7	2.92	28.7	98.7	3.88	5.3	1250	51.5	33.4	0.65	2.06	58.5	25.0	1.9
				1500	39.8	2.92	29.8	94.5	3.98	4.9	1500	53.0	37.9	0.72	2.17	60.4	24.4	2.0
	10.0	2.5	5.7	1250	39.3	2.98	29.1	99.1	3.87	5.5	1250	51.7	33.7	0.65	1.98	58.4	26.0	1.8
				1500	40.2	2.96	30.1	94.8	3.98	5.1	1500	53.2	38.2	0.72	2.08	60.3	25.6	1.9
				1250	40.5	3.00	30.3	100.0	3.96	5.7	1250	51.8	33.7	0.65	1.95	58.4	26.6	1.6
	14.0	4.7	10.9	1500	41.4	2.98	31.2	95.6	4.07	5.2	1500	53.3	38.2	0.72	2.04	60.3	26.1	1.8
	60	6.0	1.1	2.6	1250	43.9	3.02	33.6	102.5	4.26	6.0	1250	49.4	32.8	0.66	2.30	57.3	21.5
1500					44.8	3.00	34.6	97.7	4.38	5.5	1500	50.9	37.0	0.73	2.41	59.1	21.2	2.8
10.0		2.4	5.5	1250	45.3	3.08	34.8	103.5	4.31	6.1	1250	49.7	33.1	0.67	2.23	57.2	22.3	2.5
				1500	46.0	3.03	35.6	98.4	4.44	5.7	1500	51.1	37.4	0.73	2.33	59.1	22.0	2.7
14.0		4.5	10.5	1250	46.3	3.10	35.7	104.3	4.38	6.3	1250	49.9	33.2	0.67	2.18	57.3	22.9	2.3
				1500	47.1	3.06	36.6	99.0	4.51	5.8	1500	51.4	37.5	0.73	2.28	59.1	22.5	2.5
70	6.0	1.1	2.5	1250	49.1	3.12	38.4	106.4	4.61	6.7	1250	47.3	32.2	0.68	2.54	56.0	18.7	3.7
				1500	49.9	3.07	39.4	100.8	4.77	6.2	1500	48.8	36.1	0.74	2.64	57.8	18.5	3.9
	10.0	2.3	5.3	1250	51.2	3.17	40.3	107.9	4.73	7.0	1250	47.6	32.5	0.68	2.47	56.1	19.3	3.4
				1500	51.7	3.10	41.1	101.9	4.89	6.4	1500	49.1	36.5	0.74	2.57	57.9	19.1	3.7
				1250	52.1	3.21	41.2	108.6	4.76	7.2	1250	47.9	32.6	0.68	2.41	56.2	19.9	3.2
	14.0	4.4	10.2	1500	52.7	3.14	42.0	102.5	4.92	6.6	1500	49.4	36.7	0.74	2.52	58.0	19.6	3.5
80	6.0	1.1	2.5	1250	52.9	3.19	42.0	109.2	4.86	7.4	1250	44.8	31.3	0.70	2.85	54.6	15.7	5.1
				1500	53.4	3.12	42.7	102.9	5.01	6.9	1500	46.2	35.0	0.76	2.95	56.3	15.7	5.4
	10.0	2.2	5.1	1250	55.9	3.24	44.8	111.4	5.05	7.7	1250	45.2	31.6	0.70	2.78	54.7	16.3	4.8
				1500	56.1	3.15	45.4	104.7	5.23	7.1	1500	46.6	35.4	0.76	2.89	56.4	16.1	5.2
				1250	56.5	3.29	45.3	111.9	5.04	7.9	1250	45.5	31.9	0.70	2.74	54.9	16.6	4.4
	14.0	4.3	9.8	1500	56.8	3.19	45.9	105.0	5.21	7.3	1500	47.0	35.6	0.76	2.84	56.6	16.6	4.9
90	6.0	1.0	2.4	1250	56.7	3.26	45.6	112.0	5.10	8.3	1250	42.3	30.5	0.72	3.17	53.1	13.4	6.8
				1500	56.9	3.17	46.0	105.1	5.25	7.7	1500	43.6	33.8	0.78	3.26	54.7	13.4	7.2
	10.0	2.1	5.0	1250	60.5	3.31	49.2	114.8	5.36	8.6	1250	42.8	30.8	0.72	3.10	53.3	13.8	6.4
				1500	60.5	3.19	49.7	107.4	5.56	7.9	1500	44.0	34.3	0.78	3.20	55.0	13.7	6.9
				1250	60.9	3.36	49.5	115.1	5.31	8.8	1250	43.1	31.1	0.72	3.06	53.5	14.1	5.9
	14.0	4.1	9.5	1500	60.8	3.24	49.7	107.5	5.50	8.2	1500	44.5	34.6	0.78	3.15	55.2	14.1	6.6
100	6.0	1.0	2.3	Operation not recommended							Operation not recommended							
	10.0	2.1	4.8	1250	39.7	29.8	0.75	3.52	51.7	11.3	8.3	Operation not recommended						
				1500	40.9	33.0	0.81	3.61	53.2	11.3	8.9	Operation not recommended						
				1250	40.1	30.2	0.75	3.47	52.0	11.6	7.7	Operation not recommended						
14.0	4.0	9.1	1500	41.4	33.4	0.81	3.56	53.5	11.6	8.5	Operation not recommended							
110	6.0	1.0	2.2	Operation not recommended							Operation not recommended							
	10.0	2.0	4.6	1250	36.7	28.9	0.79	3.94	50.1	9.3	10.4	Operation not recommended						
				1500	37.8	31.7	0.84	4.02	51.5	9.4	11.3	Operation not recommended						
				1250	37.1	29.4	0.79	3.88	50.4	9.6	9.7	Operation not recommended						
				1500	38.3	32.2	0.84	3.96	51.8	9.7	10.7	Operation not recommended						
120	6.0	0.9	2.1	Operation not recommended							Operation not recommended							
	10.0	1.9	4.4	1250	33.9	28.2	0.83	4.44	49.0	7.6	12.6	Operation not recommended						
				1500	34.5	30.6	0.89	4.55	50.0	7.6	13.6	Operation not recommended						
				1250	34.2	28.2	0.83	4.29	48.8	8.0	11.7	Operation not recommended						
14.0	3.7	8.4	1500	34.9	30.6	0.88	4.43	50.0	7.9	12.9	Operation not recommended							

Performance capacities shown in thousands of Btu/h.

11/11/13

IMPORTANT NOTE: Refer to Notes to Performance Tables for additional information.

SDV064 High Speed - Performance Data

EWT °F	Flow gpm	WPD		HEATING - EAT 70°F							COOLING - EAT 80/67 °F							
		PSI	FT	Airflow cfm	HC MBtu/h	Power kW	HE MBtu/h	LAT °F	COP	HWC MBtu/h	Airflow cfm	TC MBtu/h	SC MBtu/h	S/T Ratio	Power kW	HR MBtu/h	EER	HWC MBtu/h
20	8.0	2.0	4.6	Operation not recommended							Operation not recommended							
	12.0	4.0	9.2	Operation not recommended							Operation not recommended							
	16.0	6.6	15.1	1500	36.5	3.46	24.7	92.5	3.10	5.7	Operation not recommended							
				1800	37.4	3.62	25.1	89.2	3.03	5.2	Operation not recommended							
30	8.0	1.9	4.5	Operation not recommended							Operation not recommended							
	12.0	3.9	8.9	1500	42.6	3.56	30.4	96.3	3.50	6.1	1500	62.4	40.9	0.66	2.76	71.9	22.6	-
				1800	43.7	3.79	30.8	92.5	3.38	5.6	1800	63.5	44.7	0.70	2.91	73.4	21.8	-
	16.0	6.4	14.7	1500	43.2	3.65	30.7	96.6	3.46	6.3	1500	62.8	40.9	0.65	2.68	71.9	23.5	-
				1800	44.2	3.82	31.2	92.7	3.39	5.7	1800	64.3	44.7	0.70	2.81	73.9	22.9	-
Operation not recommended							Operation not recommended											
40	8.0	1.9	4.3	Operation not recommended							Operation not recommended							
	12.0	3.7	8.7	1500	49.5	3.81	36.5	100.6	3.81	6.9	1500	65.6	42.6	0.65	3.05	76.0	21.5	-
				1800	50.6	3.97	37.1	96.0	3.74	6.3	1800	66.8	46.6	0.70	3.20	77.8	20.9	-
	16.0	6.2	14.3	1500	50.3	3.87	37.0	101.0	3.80	7.1	1500	66.1	42.6	0.64	2.96	76.2	22.3	-
				1800	51.4	4.01	37.7	96.4	3.76	6.5	1800	67.6	46.6	0.69	3.10	78.2	21.8	-
Operation not recommended							Operation not recommended											
50	8.0	1.8	4.2	1500	53.3	3.97	39.8	102.9	3.93	7.4	1500	68.1	43.7	0.64	3.30	79.4	20.6	3.8
				1800	54.5	4.10	40.5	98.0	3.90	6.9	1800	69.5	47.5	0.68	3.51	81.5	19.8	4.0
	12.0	3.6	8.4	1500	56.4	4.05	42.6	104.8	4.08	7.7	1500	68.8	44.1	0.64	3.24	79.9	21.3	3.6
				1800	57.6	4.15	43.4	99.6	4.07	7.1	1800	70.2	48.0	0.68	3.44	81.9	20.4	3.9
				1500	57.4	4.10	43.4	105.4	4.11	7.9	1500	69.5	44.6	0.64	3.18	80.4	21.9	3.3
	16.0	6.0	13.8	1800	58.6	4.20	44.3	100.1	4.09	7.2	1800	70.9	48.4	0.68	3.38	82.4	21.0	3.7
				Operation not recommended							Operation not recommended							
60	8.0	1.8	4.1	1500	60.0	4.25	45.5	107.0	4.14	8.3	1500	66.5	43.3	0.65	3.56	78.6	18.7	4.6
				1800	61.3	4.32	46.5	101.5	4.16	7.7	1800	68.2	47.0	0.69	3.79	81.1	18.0	4.9
	12.0	3.5	8.1	1500	62.7	4.32	48.0	108.7	4.26	8.6	1500	67.1	43.7	0.65	3.49	79.1	19.2	4.3
				1800	64.1	4.37	49.1	102.9	4.29	7.9	1800	68.9	47.5	0.69	3.71	81.5	18.6	4.7
	16.0	5.8	13.4	1500	64.1	4.37	49.2	109.5	4.30	8.9	1500	67.8	44.1	0.65	3.43	79.5	19.8	4.0
				1800	65.5	4.42	50.4	103.7	4.35	8.1	1800	69.6	48.0	0.69	3.65	82.0	19.1	4.4
70	8.0	1.7	3.9	1500	66.5	4.52	51.1	111.1	4.32	9.4	1500	64.8	42.9	0.66	3.82	77.9	17.0	5.6
				1800	68.0	4.54	52.5	105.0	4.39	8.7	1800	66.8	46.6	0.70	4.07	80.7	16.4	6.0
	12.0	3.4	7.9	1500	69.0	4.58	53.4	112.6	4.41	9.7	1500	65.4	43.3	0.66	3.75	78.2	17.5	5.3
				1800	70.5	4.59	54.9	106.3	4.50	8.9	1800	67.6	47.0	0.70	3.98	81.2	17.0	5.7
	16.0	5.6	12.9	1500	70.7	4.64	54.9	113.7	4.47	10.0	1500	66.1	43.7	0.66	3.68	78.7	17.9	4.9
				1800	72.4	4.64	56.6	107.2	4.58	9.2	1800	68.2	47.5	0.70	3.92	81.6	17.4	5.4
80	8.0	1.6	3.8	1500	71.6	4.75	55.4	114.2	4.42	10.3	1500	61.6	41.5	0.67	4.15	75.7	14.8	7.3
				1800	73.2	4.72	57.1	107.7	4.54	9.6	1800	63.8	45.1	0.71	4.42	78.9	14.5	7.7
	12.0	3.3	7.6	1500	73.3	4.81	56.9	115.2	4.47	10.7	1500	62.2	41.9	0.67	4.07	76.1	15.3	6.8
				1800	75.0	4.76	58.8	108.6	4.62	9.9	1800	64.5	45.5	0.71	4.33	79.3	14.9	7.4
	16.0	5.4	12.5	1500	75.5	4.87	58.9	116.6	4.55	11.0	1500	62.8	42.4	0.67	4.00	76.4	15.7	6.3
				1800	77.4	4.81	61.0	109.8	4.72	10.1	1800	65.2	46.0	0.71	4.26	79.7	15.3	7.0
90	8.0	1.6	3.7	1500	76.6	4.98	59.6	117.3	4.51	11.4	1500	58.3	40.2	0.69	4.47	73.5	13.0	9.3
				1800	78.4	4.91	61.7	110.4	4.69	10.5	1800	60.9	43.7	0.72	4.76	77.1	12.8	9.8
	12.0	3.2	7.3	1500	77.6	5.03	60.4	117.9	4.52	11.7	1500	59.0	40.5	0.69	4.38	73.9	13.4	8.6
				1800	79.6	4.93	62.7	110.9	4.73	10.9	1800	61.4	44.1	0.72	4.67	77.3	13.2	9.4
	16.0	5.2	12.1	1500	80.3	5.10	62.9	119.6	4.62	12.1	1500	59.5	41.0	0.69	4.31	74.2	13.8	8.0
				1800	82.4	4.98	65.4	112.4	4.85	11.2	1800	62.1	44.5	0.72	4.59	77.8	13.5	8.9
100	8.0	1.5	3.5	Operation not recommended							Operation not recommended							
	12.0	3.1	7.1	1500	54.9	38.9	0.71	4.79	71.2	11.4	10.5	Operation not recommended						
				1800	57.5	42.3	0.74	5.11	74.9	11.2	11.4	Operation not recommended						
	16.0	5.0	11.6	1500	55.4	39.4	0.71	4.71	71.5	11.8	9.8	Operation not recommended						
1800				58.1	42.8	0.74	5.03	75.2	11.6	10.9	Operation not recommended							
110	8.0	1.5	3.4	Operation not recommended							Operation not recommended							
	12.0	2.9	6.8	1500	50.8	37.3	0.74	5.21	68.6	9.8	13.6	Operation not recommended						
				1800	53.5	40.5	0.76	5.55	72.5	9.6	14.8	Operation not recommended						
	16.0	4.8	11.2	1500	51.3	37.7	0.74	5.11	68.7	10.0	12.7	Operation not recommended						
				1800	54.0	41.0	0.76	5.46	72.6	9.9	14.1	Operation not recommended						
Operation not recommended							Operation not recommended											
120	8.0	1.4	3.3	Operation not recommended							Operation not recommended							
	12.0	2.8	6.5	1500	48.4	36.0	0.74	6.04	69.0	8.0	16.5	Operation not recommended						
				1800	49.3	39.1	0.79	6.20	70.5	8.0	17.9	Operation not recommended						
	16.0	4.6	10.7	1500	48.9	36.0	0.74	5.85	68.8	8.4	15.3	Operation not recommended						
1800				49.9	39.1	0.78	6.03	70.5	8.3	17.0	Operation not recommended							

Performance capacities shown in thousands of Btuh.

11/11/13

IMPORTANT NOTE: Refer to Notes to Performance Tables for additional information.

SDV064 Water Heating Data

ELT	EST	LGPM	SOURCE 8.0 GPM							SWPD		HWC MBtuh	SOURCE 12.0 GPM							SWPD		HWC MBtuh	SOURCE 16.0 GPM							SWPD		HWC MBtuh
			LLT	HC	KW	HE	COP	LST	PSI	FT HD	LLT		HC	KW	HE	COP	LST	PSI	FT HD	LLT	HC		KW	HE	COP	LST	PSI	FT HD				
80	30	8.0	Operation Not Recommended																													
		12.0	88.1	43.3	3.57	31.1	3.6	22.0	2.0	4.6	5.7	88.4	44.7	3.58	32.4	3.7	23.8	4.5	10.4	5.8	88.6	46.0	3.59	33.8	3.8	25.6	7.0	16.2	5.9			
		16.0	85.4	43.2	3.49	31.3	3.6	21.9	2.0	4.6	5.5	85.6	44.6	3.50	32.7	3.7	23.8	4.5	10.4	5.6	85.8	46.0	3.51	34.0	3.8	25.6	7.0	16.2	5.7			
80	40	8.0	Operation Not Recommended																													
		12.0	89.5	50.5	3.65	38.0	4.1	30.2	1.9	4.4	6.4	89.9	52.6	3.67	40.1	4.2	32.4	4.4	10.1	6.6	90.3	54.8	3.69	42.2	4.3	34.7	6.8	15.7	6.7			
		16.0	86.3	50.5	3.55	38.4	4.2	30.1	1.9	4.4	6.2	86.6	52.7	3.57	40.5	4.3	32.4	4.4	10.1	6.3	86.8	54.8	3.59	42.5	4.5	34.7	6.8	15.7	6.5			
80	50	8.0	94.3	57.4	3.85	44.2	4.4	38.6	1.9	4.3	7.5	95.1	60.4	3.88	47.2	4.6	41.2	4.2	9.8	7.6	95.9	63.5	3.91	50.1	4.8	43.7	6.6	15.2	7.8			
		12.0	90.8	57.6	3.73	44.9	4.5	38.4	1.9	4.3	7.2	91.3	60.6	3.76	47.7	4.7	41.1	4.2	9.8	7.4	91.9	63.5	3.79	50.6	4.9	43.7	6.6	15.2	7.5			
		16.0	87.2	57.8	3.61	45.5	4.7	38.3	1.9	4.3	6.9	87.6	60.7	3.64	48.3	4.9	40.9	4.2	9.8	7.1	87.9	63.6	3.67	51.0	5.1	43.6	6.6	15.2	7.2			
80	60	8.0	96.1	64.4	3.95	50.9	4.8	46.9	1.8	4.1	8.4	97.1	68.3	3.99	54.7	5.0	49.8	4.1	9.4	8.6	98.1	72.2	4.03	58.5	5.2	52.7	6.4	14.8	8.8			
		12.0	92.1	64.8	3.81	51.8	5.0	46.7	1.8	4.1	8.1	92.8	68.5	3.85	55.4	5.2	49.6	4.1	9.4	8.3	93.5	72.3	3.89	59.0	5.4	52.6	6.4	14.8	8.5			
		16.0	88.1	65.2	3.67	52.7	5.2	46.4	1.8	4.1	7.8	88.6	68.8	3.71	56.1	5.4	49.5	4.1	9.4	8.0	89.0	72.3	3.75	59.5	5.7	52.6	6.4	14.8	8.1			
80	70	8.0	97.8	71.4	4.05	57.5	5.2	55.2	1.7	3.9	9.5	99.0	76.1	4.10	62.1	5.4	58.4	4.0	9.1	9.7	100.2	80.9	4.15	66.8	5.7	61.7	6.2	14.3	9.9			
		12.0	93.5	71.9	3.89	58.7	5.4	54.9	1.7	3.9	9.2	94.3	76.5	3.94	63.0	5.7	58.2	4.0	9.1	9.4	95.2	81.0	3.99	67.4	6.0	61.6	6.2	14.3	9.5			
		16.0	89.1	72.5	3.73	59.8	5.7	54.6	1.7	3.9	8.8	89.6	76.8	3.78	63.9	6.0	58.0	4.0	9.1	9.0	90.1	81.1	3.83	68.0	6.2	61.5	6.2	14.3	9.2			
100	30	8.0	Operation Not Recommended																													
		12.0	107.9	42.3	4.56	26.7	2.7	23.1	2.0	4.6	5.6	108.1	43.4	4.57	27.8	2.8	24.8	4.5	10.4	5.6	108.4	44.5	4.58	28.9	2.8	26.4	7.0	16.2	5.7			
		16.0	105.3	42.3	4.48	27.0	2.8	23.0	2.0	4.6	5.4	105.4	43.4	4.49	28.1	2.8	24.7	4.5	10.4	5.4	105.6	44.5	4.50	29.2	2.9	26.4	7.0	16.2	5.5			
100	40	8.0	Operation Not Recommended																													
		12.0	109.2	48.9	4.62	33.1	3.1	31.5	1.9	4.4	6.2	109.5	50.7	4.64	34.8	3.2	33.4	4.4	10.1	6.3	109.8	52.4	4.67	36.5	3.3	35.4	6.8	15.7	6.4			
		16.0	106.1	49.0	4.49	33.6	3.2	31.3	1.9	4.4	6.0	106.3	50.7	4.52	35.3	3.3	33.4	4.4	10.1	6.1	106.6	52.5	4.55	37.0	3.4	35.4	6.8	15.7	6.2			
100	50	8.0	113.8	55.4	4.84	38.9	3.4	40.0	1.9	4.3	7.2	114.4	57.8	4.86	41.2	3.5	42.3	4.2	9.8	7.3	115.0	60.2	4.89	43.5	3.6	44.6	6.6	15.2	7.4			
		12.0	110.4	55.5	4.67	39.6	3.5	39.8	1.9	4.3	6.9	110.9	57.9	4.71	41.8	3.6	42.1	4.2	9.8	7.0	111.3	60.4	4.75	44.1	3.7	44.5	6.6	15.2	7.1			
		16.0	107.0	55.6	4.51	40.2	3.6	39.6	1.9	4.3	6.7	107.3	58.1	4.56	42.5	3.7	42.0	4.2	9.8	6.8	107.6	60.5	4.61	44.8	3.8	44.4	6.6	15.2	6.9			
100	60	8.0	115.5	62.0	4.94	45.1	3.7	48.4	1.8	4.1	8.1	116.2	65.0	4.96	48.0	3.8	51.0	4.1	9.4	8.2	117.0	68.0	4.99	50.9	4.0	53.6	6.4	14.8	8.3			
		12.0	111.6	62.1	4.73	46.0	3.8	48.2	1.8	4.1	7.8	112.2	65.2	4.78	48.9	4.0	50.8	4.1	9.4	7.9	112.8	68.3	4.83	51.8	4.1	53.5	6.4	14.8	8.0			
		16.0	107.8	62.3	4.52	46.8	4.0	47.9	1.8	4.1	7.5	108.2	65.4	4.60	49.7	4.2	50.7	4.1	9.4	7.6	108.6	68.6	4.67	52.6	4.3	53.4	6.4	14.8	7.7			
100	70	8.0	117.1	68.5	5.03	51.3	4.0	56.8	1.7	3.9	9.1	118.0	72.1	5.07	54.9	4.2	59.7	4.0	9.1	9.2	118.9	75.8	5.10	58.4	4.4	62.7	6.2	14.3	9.3			
		12.0	112.9	68.7	4.79	52.4	4.2	56.5	1.7	3.9	8.8	113.6	72.4	4.85	55.9	4.4	59.5	4.0	9.1	8.9	114.3	76.2	4.92	59.4	4.5	62.6	6.2	14.3	9.0			
		16.0	108.6	68.9	4.54	53.4	4.5	56.2	1.7	3.9	8.4	109.1	72.7	4.64	56.9	4.6	59.3	4.0	9.1	8.5	109.6	76.6	4.73	60.4	4.7	62.4	6.2	14.3	8.7			
120	30	8.0	Operation Not Recommended																													
		12.0	127.7	41.3	5.56	22.3	2.2	24.2	2.0	4.6	5.4	127.9	42.2	5.57	23.2	2.2	25.6	4.5	10.4	5.5	128.1	43.0	5.58	24.0	2.3	26.9	7.0	16.2	5.5			
		16.0	125.2	41.4	5.47	22.8	2.2	24.1	2.0	4.6	5.2	125.3	42.2	5.48	23.5	2.3	25.5	4.5	10.4	5.3	125.4	43.0	5.48	24.3	2.3	26.9	7.0	16.2	5.3			
120	40	8.0	Operation Not Recommended																													
		12.0	128.9	47.3	5.59	28.3	2.5	32.7	1.9	4.4	6.0	129.1	48.7	5.61	29.6	2.5	34.4	4.4	10.1	6.1	129.4	50.1	5.64	30.9	2.6	36.1	6.8	15.7	6.1			
		16.0	125.9	47.4	5.44	28.8	2.6	32.6	1.9	4.4	5.8	126.1	48.8	5.48	30.1	2.6	34.3	4.4	10.1	5.9	126.3	50.3	5.52	31.4	2.7	36.1	6.8	15.7	5.9			
120	50	8.0	133.4	53.4	5.83	33.5	2.7	41.4	1.9	4.3	7.0	133.8	55.1	5.84	35.2	2.8	43.4	4.2	9.8	7.0	134.2	56.8	5.86	36.8	2.8	45.4	6.6	15.2	7.0			
		12.0	130.0	53.4	5.62	34.2	2.8	41.2	1.9	4.3	6.7	130.4	55.3	5.66	36.0	2.9	43.2	4.2	9.8	6.7	130.7	57.2	5.71	37.7	2.9	45.3	6.6	15.2	6.8			
		16.0	126.7	53.4	5.41	34.9	2.9	41.0	1.9	4.3	6.4	126.9	55.5	5.48	36.7	3.0	43.1	4.2	9.8	6.5	127.2	57.5	5.56	38.6	3.0	45.2	6.6	15.2	6.5			
120	60	8.0	134.9	59.6	5.92	39.3	2.9	49.9	1.8	4.1	7.8	135.4	61.6	5.94	41.4	3.0	52.2	4.1	9.4	7.8	135.9	63.7	5.95	43.4	3.1	54.6	6.4	14.8	7.7			
		12.0	131.2	59.5	5.65	40.2	3.1	49.6	1.8	4.1	7.5	131.6	61.9	5.71	42.4	3.2	52.0	4.1	9.4	7.5	132.0	64.3	5.77	44.5	3.3	54.4	6.4	14.8	7.5			
		16.0	127.4	59.3	5.38	41.0	3.2	49.4	1.8	4.1	7.1	127.8	62.1	5.49	43.3	3.3	51.8	4.1	9.4	7.2	128.1	64.8	5.60	45.7	3.4	54.3	6.4	14.8	7.3			
120	70	8.0	136.4	65.7	6.02	45.2	3.2	58.4	1.7	3.9	8.8	137.0	68.1	6.03	47.6	3.3	61.0	4.0	9.1	8.7	137.6	70.6	6.05	50.0	3.4	63.6	6.2	14.3	8.6			
		12.0	132.3	65.5	5.68	46.1	3.4	58.1	1.7	3.9	8.3	132.8	68.4	5.76	48.8	3.5	60.7	4.0	9.1	8.4	133.3	71.3	5.84	51.4	3.6	63.4	6.2	14.3	8.4			
		16.0	128.2	65.3	5.35	47.1	3.6	57.9	1.7	3.9	7.9	128.6	68.7	5.49	49.9	3.7	60.5	4.0	9.1	8.0	129.0	72.0	5.64	52.8	3.7	63.2	6.2	14.3	8.1			

* Water heating mode only allows high compressor capacity operation.

2/21/11

ELT = entering load fluid temperature to heat pump
 LLT = leaving load fluid temperature from heat pump
 LGPM = load flow in gallons per minute
 LWPD = load coax water pressure drop
 EST = entering source fluid temperature to heat pump
 LST = leaving source fluid temperature from heat pump
 HWC = hot water generator capacity

SWPD = source coax water pressure drop
 PSI = pressure drop in pounds per square inch
 FT HD = pressure drop in feet of head
 KW = kilowatts
 HE = heat extracted in Btuh
 HC = total heating capacity in Btuh
 COP = coefficient of performance [HC/(kW x 3.413)]

IMPORTANT NOTE: Refer to Notes to Performance Tables for additional information.

SDV072 Performance Data - Low Speed

EWT °F	Flow gpm	WPD		HEATING - EAT 70°F							COOLING - EAT 80/67 °F							
		PSI	FT	Airflow cfm	HC MBtu/h	Power kW	HE MBtu/h	LAT °F	COP	HWC MBtu/h	Airflow cfm	TC MBtu/h	SC MBtu/h	S/T Ratio	Power kW	HR MBtu/h	EER	HWC MBtu/h
20	10.0	2.7	6.2	Operation not recommended							Operation not recommended							
	13.0	3.5	8.1	Operation not recommended							Operation not recommended							
	16.0	6.8	15.7	1400	31.7	3.46	19.9	91.0	2.69	5.9	Operation not recommended							
30	10.0	2.6	6.0	Operation not recommended							Operation not recommended							
				1400	32.9	3.50	21.0	91.8	2.76	5.5	1400	53.8	33.7	0.63	2.30	61.6	23.4	-
	13.0	3.4	7.9	1700	34.5	3.54	22.4	88.8	2.86	5.0	1700	54.6	36.9	0.67	2.42	62.9	22.6	-
				1400	34.3	3.50	22.4	92.7	2.88	5.7	1400	54.0	33.7	0.62	2.23	61.6	24.2	-
	16.0	6.6	15.2	1700	36.0	3.54	23.9	89.6	2.98	5.1	1700	55.4	36.9	0.67	2.34	63.3	23.7	-
40	10.0	2.5	5.9	Operation not recommended							Operation not recommended							
				1400	40.9	3.65	28.5	97.1	3.29	6.5	1400	53.7	33.8	0.63	2.31	61.6	23.3	-
	13.0	3.3	7.6	1700	42.7	3.66	30.2	93.3	3.42	5.9	1700	54.7	36.9	0.67	2.42	63.0	22.6	-
				1400	42.4	3.66	29.9	98.0	3.39	6.7	1400	54.1	33.8	0.62	2.24	61.8	24.2	-
	16.0	6.4	14.8	1700	44.3	3.67	31.7	94.1	3.53	6.1	1700	58.6	39.3	0.67	2.57	67.3	22.8	-
50	10.0	2.5	5.7	1400	40.6	3.63	28.3	96.9	3.28	6.8	1400	59.6	36.4	0.61	2.82	69.3	21.1	2.3
				1700	42.5	3.59	30.2	93.1	3.46	6.3	1700	61.5	41.3	0.67	2.97	71.6	20.7	2.4
	13.0	3.2	7.4	1400	41.2	3.67	28.7	97.3	3.29	7.0	1400	59.8	36.7	0.61	2.73	69.1	21.9	2.1
				1700	42.9	3.65	30.4	93.4	3.44	6.4	1700	61.6	41.7	0.68	2.87	71.4	21.5	2.3
	16.0	6.2	14.3	1400	42.5	3.69	29.9	98.1	3.37	7.2	1400	59.9	36.7	0.61	2.66	69.0	22.6	2.0
60	10.0	2.4	5.5	1400	40.5	3.66	28.0	96.8	3.24	7.5	1400	53.3	32.2	0.61	2.37	61.3	22.5	3.2
				1700	42.2	3.58	29.9	93.0	3.45	6.9	1700	54.9	36.4	0.66	2.47	63.3	22.2	3.4
	13.0	3.1	7.2	1400	41.6	3.70	29.0	97.5	3.30	7.7	1400	53.5	32.6	0.61	2.29	61.3	23.4	3.0
				1700	43.2	3.63	30.9	93.6	3.49	7.1	1700	55.1	36.8	0.67	2.39	63.2	23.0	3.2
	16.0	6.0	13.9	1400	42.6	3.74	29.8	98.1	3.34	7.9	1400	53.7	32.6	0.61	2.24	61.4	23.9	2.8
70	10.0	2.3	5.3	1400	40.3	3.69	27.7	96.7	3.20	8.3	1400	53.1	32.3	0.61	2.37	61.1	22.4	4.4
				1700	42.0	3.58	29.8	92.9	3.44	7.7	1700	54.6	36.3	0.67	2.46	63.0	22.2	4.6
	13.0	3.0	6.9	1400	41.9	3.73	29.1	97.7	3.29	8.5	1400	53.4	32.7	0.61	2.29	61.2	23.3	4.1
				1700	43.5	3.62	31.2	93.7	3.53	7.9	1700	54.9	36.7	0.67	2.39	63.0	23.0	4.4
	16.0	5.8	13.4	1400	42.6	3.78	29.7	98.2	3.30	8.8	1400	53.7	32.8	0.61	2.26	61.4	23.7	3.8
80	10.0	2.2	5.1	1400	40.2	3.71	27.5	96.6	3.17	9.2	1400	52.9	32.4	0.61	2.37	61.0	22.3	6.2
				1700	41.7	3.58	29.4	92.7	3.41	8.5	1700	54.4	36.2	0.67	2.44	62.8	22.3	6.6
	13.0	2.9	6.7	1400	42.3	3.76	29.5	98.0	3.30	9.5	1400	53.3	32.8	0.62	2.31	61.2	23.0	5.8
				1700	43.8	3.61	31.5	93.9	3.56	8.8	1700	54.9	36.7	0.67	2.38	63.0	23.0	6.3
	16.0	5.6	12.9	1400	42.8	3.81	29.8	98.3	3.29	9.8	1400	53.7	33.0	0.61	2.28	61.5	23.6	5.4
90	10.0	2.1	5.0	1400	40.1	3.74	27.3	96.5	3.14	10.3	1400	52.6	32.6	0.62	2.38	60.7	22.1	8.0
				1700	41.4	3.58	29.2	92.5	3.38	9.5	1700	54.3	36.1	0.67	2.43	62.5	22.4	8.5
	13.0	2.8	6.5	1400	42.6	3.79	29.7	98.2	3.30	10.6	1400	53.2	32.9	0.62	2.33	61.1	22.8	7.5
				1700	44.1	3.60	31.8	94.0	3.59	9.8	1700	54.8	36.6	0.67	2.38	62.9	23.1	8.1
	16.0	5.4	12.5	1400	42.9	3.84	29.8	98.4	3.27	11.0	1400	53.7	33.2	0.62	2.29	61.5	23.4	6.9
100	10.0	2.1	4.8	Operation not recommended							Operation not recommended							
	13.0	2.7	6.2	Operation not recommended							1400	53.0	32.9	0.62	2.35	61.0	22.6	10.0
	16.0	5.2	12.0	Operation not recommended							1700	54.8	36.5	0.67	2.37	62.9	23.1	10.9
				Operation not recommended							1400	53.7	33.3	0.62	2.31	61.6	23.3	9.3
110	10.0	2.0	4.6	Operation not recommended							Operation not recommended							
				Operation not recommended							1400	52.9	33.0	0.62	2.36	60.9	22.4	12.7
	13.0	2.6	6.0	Operation not recommended							1700	54.7	36.4	0.67	2.37	62.8	23.1	13.8
				Operation not recommended							1400	53.8	33.5	0.62	2.33	61.7	23.1	11.8
	16.0	5.0	11.6	Operation not recommended							1700	45.6	36.6	0.80	4.94	62.5	9.2	13.1
120	10.0	1.9	4.4	Operation not recommended							Operation not recommended							
	13.0	2.5	5.8	Operation not recommended							1400	53.7	34.0	0.63	2.34	61.7	22.9	15.8
				Operation not recommended							1700	54.7	36.9	0.67	2.41	62.9	22.7	17.1
	16.0	4.8	11.1	Operation not recommended							1400	54.2	34.0	0.63	2.27	61.9	23.9	14.6
Operation not recommended							1700	42.3	35.3	0.83	5.45	60.9	7.8	16.3				

Performance capacities shown in thousands of Btu/h.

11/11/13

IMPORTANT NOTE: Refer to Notes to Performance Tables for additional information.

SDV072 High Speed - Performance Data

EWT °F	Flow gpm	WPD		HEATING - EAT 70°F							COOLING - EAT 80/67 °F							
		PSI	FT	Airflow cfm	HC MBtu/h	Power kW	HE MBtu/h	LAT °F	COP	HWC MBtu/h	Airflow cfm	TC MBtu/h	SC MBtu/h	S/T Ratio	Power kW	HR MBtu/h	EER	HWC MBtu/h
20	12.0	4.0	9.2	Operation not recommended							Operation not recommended							
	15.0	5.9	13.5	Operation not recommended							Operation not recommended							
	18.0	8.3	19.2	1850	45.2	4.40	30.2	92.6	3.01	7.9	Operation not recommended							
				2200	46.9	4.68	30.9	89.7	2.93	7.1	Operation not recommended							
30	12.0	3.9	8.9	Operation not recommended							Operation not recommended							
	15.0	5.7	13.1	1850	52.3	4.56	36.7	96.2	3.36	8.3	1850	68.5	44.5	0.65	3.92	81.8	17.5	-
				2200	54.1	4.85	37.6	92.8	3.27	7.6	2200	69.6	48.6	0.70	4.13	83.6	16.9	-
				1850	52.7	4.60	37.0	96.4	3.36	8.5	1850	68.8	44.5	0.65	3.80	81.8	18.1	-
				2200	54.7	4.90	37.9	93.0	3.27	7.7	2200	70.5	48.6	0.69	3.99	84.1	17.7	-
18.0	8.1	18.6	Operation not recommended							Operation not recommended								
40	12.0	3.7	8.7	Operation not recommended							Operation not recommended							
	15.0	5.5	12.7	1850	60.3	4.86	43.7	100.2	3.64	9.2	1850	72.3	46.7	0.65	4.24	86.8	17.0	-
				2200	62.4	5.09	45.0	96.3	3.59	8.4	2200	73.7	51.0	0.69	4.45	88.8	16.6	-
				1850	61.2	4.92	44.4	100.6	3.65	9.5	1850	72.9	46.7	0.64	4.12	86.9	17.7	-
				2200	63.3	5.14	45.8	96.6	3.61	8.6	2200	74.5	51.0	0.68	4.31	89.2	17.3	-
18.0	7.8	18.1	Operation not recommended							Operation not recommended								
50	12.0	3.6	8.4	1850	64.8	5.07	47.5	102.4	3.75	9.9	1850	75.4	48.2	0.64	4.51	90.8	16.7	4.3
				2200	67.0	5.25	49.1	98.2	3.74	9.2	2200	77.0	52.3	0.68	4.79	93.3	16.1	4.5
	15.0	5.3	12.3	1850	68.4	5.16	50.8	104.2	3.88	10.2	1850	76.2	48.7	0.64	4.41	91.3	17.3	4.0
				2200	70.7	5.33	52.5	99.7	3.89	9.4	2200	77.7	52.9	0.68	4.69	93.7	16.6	4.3
				1850	69.6	5.22	51.8	104.9	3.91	10.5	1850	77.0	49.6	0.64	4.34	91.8	17.7	3.7
				2200	71.9	5.38	53.6	100.3	3.92	9.6	2200	78.5	53.4	0.68	4.62	94.3	17.0	4.1
18.0	7.6	17.5	Operation not recommended							Operation not recommended								
60	12.0	3.5	8.1	1850	72.9	5.43	54.4	106.5	3.94	11.1	1850	74.8	48.6	0.65	4.82	91.2	15.5	5.2
				2200	75.3	5.53	56.4	101.7	3.99	10.3	2200	76.4	52.5	0.69	5.12	93.8	14.9	5.5
	15.0	5.2	11.9	1850	76.2	5.52	57.3	108.1	4.04	11.5	1850	75.5	49.1	0.65	4.72	91.6	16.0	4.9
				2200	78.6	5.61	59.5	103.1	4.11	10.6	2200	77.1	53.1	0.69	5.02	94.2	15.4	5.3
				1850	77.9	5.59	58.8	109.0	4.08	11.8	1850	76.4	49.8	0.65	4.64	92.2	16.5	4.5
				2200	80.4	5.67	61.1	103.9	4.16	10.9	2200	77.9	53.6	0.69	4.94	94.7	15.8	5.0
18.0	7.3	17.0	Operation not recommended							Operation not recommended								
70	12.0	3.4	7.9	1850	81.1	5.78	61.3	110.6	4.11	12.5	1850	74.1	49.0	0.66	5.13	91.7	14.4	6.6
				2200	83.6	5.82	63.8	105.2	4.21	11.6	2200	75.7	52.7	0.70	5.46	94.3	13.9	6.9
	15.0	5.0	11.6	1850	83.9	5.87	63.9	112.0	4.19	12.9	1850	74.9	49.5	0.66	5.03	92.0	14.9	6.1
				2200	86.6	5.89	66.5	106.4	4.31	11.9	2200	76.4	53.2	0.70	5.34	94.6	14.3	6.6
				1850	86.1	5.95	65.8	113.1	4.24	13.3	1850	75.7	50.1	0.66	4.94	92.5	15.3	5.7
				2200	88.9	5.95	68.6	107.4	4.38	12.3	2200	77.2	53.9	0.70	5.26	95.2	14.7	6.3
18.0	7.1	16.4	Operation not recommended							Operation not recommended								
80	12.0	3.3	7.6	1850	87.1	6.12	66.2	113.6	4.17	13.9	1850	70.4	47.4	0.67	5.44	89.0	12.9	8.4
				2200	89.9	6.07	69.2	107.8	4.34	12.8	2200	71.9	51.2	0.71	5.79	91.7	12.4	8.9
	15.0	4.8	11.2	1850	89.2	6.20	68.0	114.6	4.22	14.3	1850	71.1	47.8	0.67	5.33	89.3	13.3	7.8
				2200	92.0	6.12	71.1	108.7	4.41	13.2	2200	72.6	51.7	0.71	5.67	91.9	12.8	8.4
				1850	91.9	6.28	70.5	116.0	4.29	14.7	1850	71.9	48.5	0.68	5.24	89.8	13.7	7.2
				2200	94.9	6.18	73.8	110.0	4.50	13.6	2200	73.4	52.2	0.71	5.58	92.4	13.1	8.0
18.0	6.9	15.9	Operation not recommended							Operation not recommended								
90	12.0	3.2	7.3	1850	93.1	6.45	71.1	116.6	4.23	15.4	1850	66.7	45.7	0.68	5.75	86.4	11.6	10.5
				2200	96.2	6.32	74.6	110.5	4.46	14.3	2200	68.1	49.6	0.73	6.12	89.0	11.1	11.1
	15.0	4.7	10.8	1850	94.4	6.52	72.2	117.3	4.25	15.9	1850	67.4	46.1	0.68	5.63	86.6	12.0	9.8
				2200	97.5	6.35	75.8	111.0	4.50	14.7	2200	68.8	50.1	0.73	6.00	89.2	11.5	10.6
				1850	97.7	6.61	75.1	118.9	4.33	16.4	1850	68.1	47.0	0.69	5.54	87.0	12.3	9.1
				2200	100.9	6.42	79.0	112.5	4.61	15.2	2200	69.5	50.6	0.73	5.90	89.6	11.8	10.1
18.0	6.6	15.3	Operation not recommended							Operation not recommended								
100	12.0	3.1	7.1	Operation not recommended							Operation not recommended							
	15.0	4.5	10.4	1850	63.3	44.8	0.71	6.10	84.1	10.4	12.2							
				2200	64.6	48.4	0.75	6.49	86.8	10.0	13.2							
				1850	64.0	45.4	0.71	6.00	84.5	10.7	11.3							
18.0	6.4	14.7	2200	65.3	48.9	0.75	6.38	87.1	10.2	12.5								
110	12.0	2.9	6.8	Operation not recommended							Operation not recommended							
	15.0	4.3	10.0	1850	59.3	43.4	0.73	6.56	81.7	9.0	14.9							
				2200	60.5	46.7	0.77	6.98	84.4	8.7	16.1							
				1850	60.0	43.8	0.73	6.45	82.0	9.3	13.8							
				2200	61.2	47.1	0.77	6.86	84.6	8.9	15.3							
18.0	6.1	14.2	Operation not recommended							Operation not recommended								
120	12.0	2.8	6.5	Operation not recommended							Operation not recommended							
	15.0	4.2	9.6	1850	55.3	41.7	0.75	7.45	80.7	7.4	18.0							
				2200	56.3	45.3	0.80	7.65	82.4	7.4	19.5							
				1850	55.8	41.7	0.75	7.21	80.4	7.7	16.7							
18.0	5.9	13.6	2200	57.0	45.3	0.79	7.44	82.4	7.7	18.5								

Performance capacities shown in thousands of Btu/h.

11/11/13

IMPORTANT NOTE: Refer to Notes to Performance Tables for additional information.

SDV072 Water Heating Data

ELT	EST	LGPM	SOURCE 12.0 GPM							SWPD		HWC MBtuh	SOURCE 15.0 GPM							SWPD		HWC MBtuh	SOURCE 18.0 GPM							SWPD		HWC MBtuh
			LLT	HC	KW	HE	COP	LST	PSI	FT HD	LLT		HC	KW	HE	COP	LST	PSI	FT HD	LLT	HC		KW	HE	COP	LST	PSI	FT HD				
80	30	12.0	Operation Not Recommended																													
		15.0	87.3	52.9	4.07	39.0	3.8	23.3	4.0	9.2	7.7	87.5	53.8	4.08	39.9	3.9	24.3	6.2	14.2	7.9	87.6	54.7	4.10	40.7	3.9	25.3	8.3	19.2	8.1			
		18.0	85.9	52.9	4.03	39.1	3.8	23.3	4.0	9.2	7.4	86.0	53.8	4.04	40.0	3.9	24.3	6.2	14.2	7.6	86.1	54.7	4.05	40.9	4.0	25.3	8.3	19.2	7.7			
80	40	12.0	Operation Not Recommended																													
		15.0	88.6	61.8	4.20	47.4	4.3	31.9	3.9	9.0	8.6	88.7	63.0	4.22	48.6	4.4	33.1	6.0	13.8	8.8	88.9	64.2	4.24	49.7	4.4	34.5	8.1	18.6	9.0			
		18.0	86.9	61.8	4.16	47.6	4.4	31.8	3.9	9.0	8.3	87.0	63.0	4.17	48.7	4.4	33.1	6.0	13.8	8.5	87.1	64.2	4.19	49.9	4.5	34.5	8.1	18.6	8.6			
80	50	12.0	91.8	70.7	4.38	55.7	4.7	40.4	3.8	8.7	10.0	92.0	72.2	4.41	57.1	4.8	42.0	5.8	13.3	10.2	92.3	73.7	4.44	58.6	4.9	43.5	7.8	18.0	10.4			
		15.0	89.8	70.6	4.33	55.9	4.8	40.4	3.8	8.7	9.6	90.0	72.2	4.36	57.3	4.9	41.9	5.8	13.3	9.8	90.2	73.7	4.39	58.7	4.9	43.5	7.8	18.0	10.0			
		18.0	87.8	70.6	4.28	56.0	4.8	40.4	3.8	8.7	9.2	88.0	72.2	4.31	57.5	4.9	41.9	5.8	13.3	9.4	88.2	73.7	4.33	58.9	5.0	43.5	7.8	18.0	9.6			
80	60	12.0	93.3	79.5	4.52	64.1	5.2	49.0	3.6	8.4	11.3	93.6	81.4	4.55	65.8	5.2	50.7	5.6	12.9	11.5	93.9	83.2	4.59	67.6	5.3	52.5	7.6	17.4	11.7			
		15.0	91.0	79.5	4.46	64.3	5.2	49.0	3.6	8.4	10.8	91.3	81.3	4.49	66.0	5.3	50.7	5.6	12.9	11.1	91.6	83.2	4.53	67.7	5.4	52.5	7.6	17.4	11.3			
		18.0	88.8	79.5	4.40	64.5	5.3	48.9	3.6	8.4	10.4	89.0	81.3	4.44	66.2	5.4	50.7	5.6	12.9	10.6	89.2	83.1	4.47	67.9	5.4	52.5	7.6	17.4	10.9			
80	70	12.0	94.7	88.4	4.65	72.6	5.6	57.5	3.5	8.1	12.7	95.1	90.6	4.69	74.6	5.7	59.5	5.4	12.5	13.0	95.5	92.7	4.73	76.5	5.7	61.5	7.3	16.9	13.2			
		15.0	92.3	88.4	4.59	72.7	5.6	57.5	3.5	8.1	12.2	92.6	90.5	4.63	74.7	5.7	59.5	5.4	12.5	12.5	92.9	92.7	4.67	76.7	5.8	61.5	7.3	16.9	12.7			
		18.0	89.8	88.4	4.53	72.9	5.7	57.5	3.5	8.1	11.8	90.1	90.5	4.57	74.9	5.8	59.5	5.4	12.5	12.0	90.3	92.6	4.61	76.9	5.9	61.5	7.3	16.9	12.3			
100	30	12.0	Operation Not Recommended																													
		15.0	107.1	51.1	5.13	33.6	2.9	24.2	4.0	9.2	7.5	107.2	51.8	5.13	34.3	3.0	25.2	6.2	14.2	7.6	107.3	52.6	5.13	35.0	3.0	26.1	8.3	19.2	7.7			
		18.0	105.7	51.1	5.08	33.7	2.9	24.2	4.0	9.2	7.2	105.8	51.8	5.08	34.4	3.0	25.1	6.2	14.2	7.3	105.8	52.5	5.09	35.2	3.0	26.1	8.3	19.2	7.4			
100	40	12.0	Operation Not Recommended																													
		15.0	108.2	59.2	5.24	41.4	3.3	32.9	3.9	9.0	8.3	108.4	60.2	5.25	42.3	3.4	34.0	6.0	13.8	8.4	108.5	61.2	5.26	43.2	3.4	35.2	8.1	18.6	8.5			
		18.0	106.6	59.2	5.18	41.5	3.3	32.9	3.9	9.0	7.9	106.7	60.2	5.19	42.5	3.4	34.0	6.0	13.8	8.1	106.8	61.2	5.21	43.4	3.4	35.2	8.1	18.6	8.2			
100	50	12.0	111.2	67.4	5.41	48.9	3.6	41.6	3.8	8.7	9.5	111.4	68.6	5.43	50.0	3.7	43.0	5.8	13.3	9.7	111.6	69.8	5.45	51.2	3.8	44.3	7.8	18.0	9.8			
		15.0	109.4	67.4	5.35	49.1	3.7	41.6	3.8	8.7	9.2	109.5	68.6	5.37	50.3	3.7	42.9	5.8	13.3	9.3	109.7	69.8	5.39	51.4	3.8	44.3	7.8	18.0	9.5			
		18.0	107.5	67.4	5.29	49.3	3.7	41.5	3.8	8.7	8.8	107.6	68.6	5.30	50.5	3.8	42.9	5.8	13.3	9.0	107.8	69.8	5.32	51.7	3.8	44.3	7.8	18.0	9.1			
100	60	12.0	112.6	75.5	5.53	56.6	4.0	50.3	3.6	8.4	10.7	112.8	77.0	5.56	58.0	4.1	51.8	5.6	12.9	10.9	113.1	78.4	5.59	59.3	4.1	53.4	7.6	17.4	11.0			
		15.0	110.5	75.5	5.46	56.9	4.1	50.2	3.6	8.4	10.3	110.7	77.0	5.49	58.2	4.1	51.8	5.6	12.9	10.5	110.9	78.4	5.51	59.6	4.2	53.4	7.6	17.4	10.6			
		18.0	108.4	75.5	5.39	57.1	4.1	50.2	3.6	8.4	9.9	108.6	77.0	5.42	58.5	4.2	51.8	5.6	12.9	10.1	108.7	78.5	5.44	59.9	4.2	53.3	7.6	17.4	10.2			
100	70	12.0	113.9	83.7	5.65	64.4	4.3	58.9	3.5	8.1	12.0	114.2	85.3	5.69	65.9	4.4	60.7	5.4	12.5	12.2	114.5	87.0	5.72	67.5	4.5	62.5	7.3	16.9	12.4			
		15.0	111.6	83.7	5.57	64.6	4.4	58.9	3.5	8.1	11.6	111.9	85.4	5.61	66.2	4.5	60.7	5.4	12.5	11.8	112.1	87.1	5.64	67.8	4.5	62.5	7.3	16.9	12.0			
		18.0	109.3	83.7	5.50	64.9	4.5	58.8	3.5	8.1	11.1	109.5	85.4	5.53	66.5	4.5	60.6	5.4	12.5	11.3	109.7	87.1	5.56	68.2	4.6	62.4	7.3	16.9	11.5			
120	30	12.0	Operation Not Recommended																													
		15.0	126.9	49.3	6.18	28.2	2.3	25.2	4.0	9.2	7.2	126.9	49.8	6.18	28.8	2.4	25.9	6.2	14.2	7.3	127.0	50.4	6.17	29.3	2.4	26.6	8.3	19.2	7.4			
		18.0	125.5	49.2	6.12	28.3	2.4	25.1	4.0	9.2	6.9	125.5	49.8	6.12	28.9	2.4	25.9	6.2	14.2	7.0	125.6	50.3	6.13	29.4	2.4	26.6	8.3	19.2	7.1			
120	40	12.0	Operation Not Recommended																													
		15.0	127.9	56.7	6.27	35.3	2.6	33.9	3.9	9.0	7.9	128.0	57.4	6.28	36.0	2.7	34.9	6.0	13.8	8.0	128.1	58.2	6.28	36.7	2.7	35.9	8.1	18.6	8.1			
		18.0	126.3	56.6	6.21	35.5	2.7	33.9	3.9	9.0	7.6	126.4	57.4	6.21	36.2	2.7	34.9	6.0	13.8	7.7	126.5	58.2	6.22	36.9	2.7	35.9	8.1	18.6	7.8			
120	50	12.0	130.7	64.1	6.44	42.1	2.9	42.8	3.8	8.7	9.1	130.8	65.0	6.45	43.0	3.0	43.9	5.8	13.3	9.2	131.0	65.9	6.46	43.8	3.0	45.1	7.8	18.0	9.3			
		15.0	128.9	64.1	6.37	42.4	2.9	42.7	3.8	8.7	8.7	129.0	65.0	6.38	43.3	3.0	43.9	5.8	13.3	8.8	129.2	65.9	6.39	44.1	3.0	45.1	7.8	18.0	8.9			
		18.0	127.1	64.1	6.29	42.6	3.0	42.7	3.8	8.7	8.4	127.2	65.0	6.30	43.5	3.0	43.9	5.8	13.3	8.5	127.3	66.0	6.31	44.4	3.1	45.1	7.8	18.0	8.6			
120	60	12.0	131.9	71.5	6.55	49.1	3.2	51.6	3.6	8.4	10.1	132.1	72.5	6.57	50.1	3.2	52.9	5.6	12.9	10.2	132.3	73.6	6.58	51.1	3.3	54.3	7.6	17.4	10.4			
		15.0	129.9	71.5	6.46	49.5	3.2	51.5	3.6	8.4	9.7	130.1	72.6	6.48	50.5	3.3	52.8	5.6	12.9	9.9	130.2	73.7	6.50	51.5	3.3	54.3	7.6	17.4	10.0			
		18.0	127.9	71.5	6.38	49.8	3.3	51.5	3.6	8.4	9.4	128.1	72.7	6.39	50.9	3.3	52.8	5.6	12.9	9.5	128.2	73.8	6.41	52.0	3.4	54.2	7.6	17.4	9.6			
120	70	12.0	133.1	78.9	6.65	56.2	3.5	60.4	3.5	8.1	11.3	133.3	80.1	6.68	57.3	3.5	61.8	5.4	12.5	11.5	133.5	81.3	6.71	58.4	3.6	63.3	7.3	16.9	11.6			
		15.0	131.0	78.9	6.56	56.5	3.5	60.3	3.5	8.1	10.9	131.1	80.2	6.58	57.7	3.6	61.8	5.4	12.5	11.1	131.3	81.5	6.60	58.9	3.6	63.2	7.3	16.9	11.2			
		18.0	128.8	79.0	6.47	56.9	3.6	60.2	3.5	8.1	10.5	128.9	80.3	6.48	58.2	3.6	61.7	5.4	12.5	10.7	129.1	81.7	6.50	59.5	3.7	63.2	7.3	16.9	10.8			

* Water heating mode only allows high compressor capacity operation.

2/21/11

ELT = entering load fluid temperature to heat pump
 LLT = leaving load fluid temperature from heat pump
 LGPM = load flow in gallons per minute
 LWPD = load coax water pressure drop
 EST = entering source fluid temperature to heat pump
 LST = leaving source fluid temperature from heat pump
 HWC = hot water generator capacity

SWPD = source coax water pressure drop
 PSI = pressure drop in pounds per square inch
 FT HD = pressure drop in feet of head
 KW = kilowatts
 HE = heat extracted in Btuh
 HC = total heating capacity in Btuh
 COP = coefficient of performance [HC/(kW x 3.413)]

IMPORTANT NOTE: Refer to Notes to Performance Tables for additional information.

Wiring Schematics cont.

208-230/60/1 ECM cont.

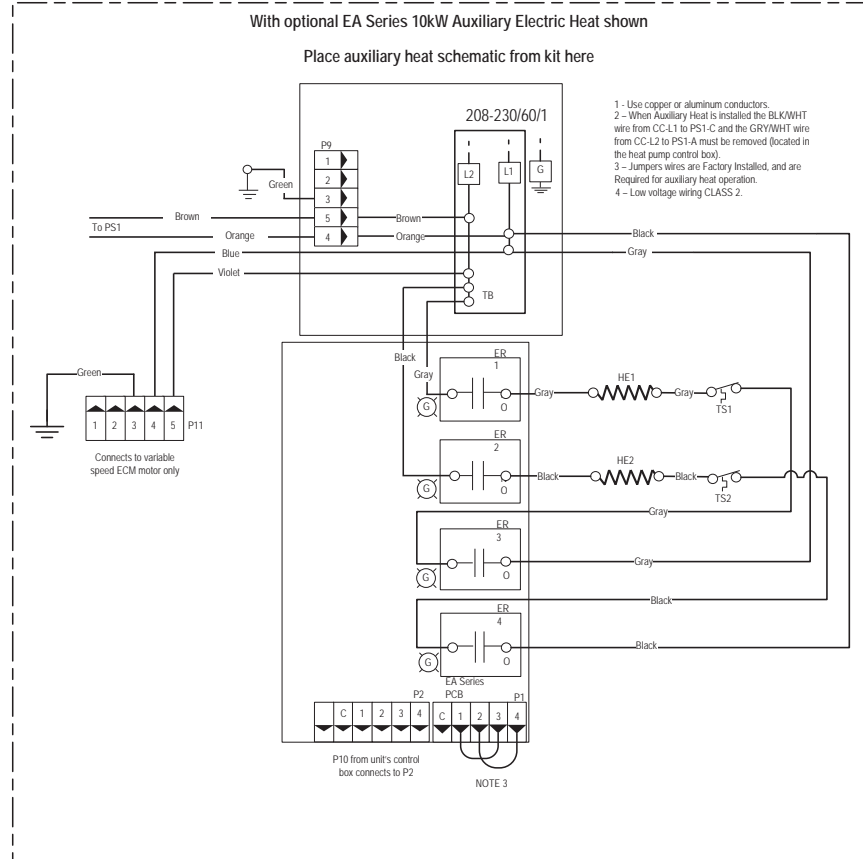
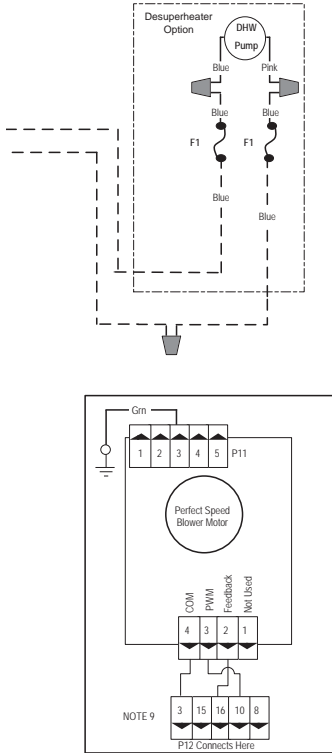

- 1 - Use copper or aluminum conductors.
- 2 - When Auxiliary Heat is installed the BLK/WHT wire from CC-L1 to PS1-C and the GRW/WHT wire from CC-L2 to PS1-A must be removed (located in the heat pump control box).
- 3 - Jumpers wires are Factory Installed, and are Required for auxiliary heat operation.
- 4 - Low voltage wiring CLASS 2.

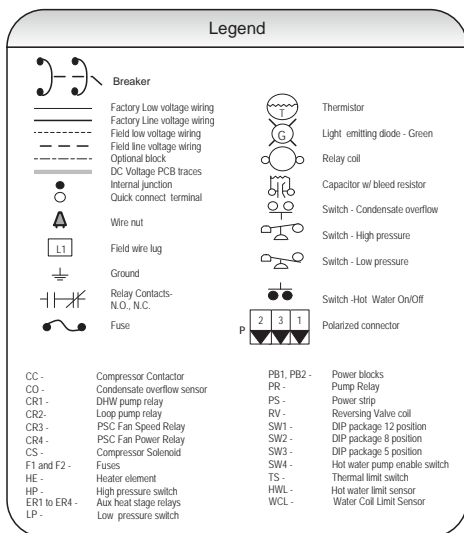

Operation Logic Table	Heating			Cooling			Hot Water Mode
	STG1	STG2	STG3	EMERG	STG1	STG2	
Compressor	On	On	On	Off	On	On	Stg 2 On
Reversing Valve	Off	Off	Off	Off	On	On	Off
Loop Pump	On	On	On	Off	On	On	On
Load Pump	Off	Off	Off	Off	Off	Off	On
Aux Heater	Off	Off	Staged	Staged	Off	Off	Off
Acc Relay	On	On	On	On	On	On	Off
Diverting Valve	Off	Off	Off	Off	Off	Off	On
ECM Speed	On	On	On	On	On	On	Off
T-Stat Signal	Y1	Y1, Y2	Y1, Y2, W	W	Y1, O	Y1, Y2, O	HW
Damper	Off	Off	Off	On	Off	Off	Off
Auxiliary 1 - Out	On	On	On	Off	On	On	On

- ### Notes
- Switch blue and red wires for 208V operation.
 - Typical hook-up shown for power open - power closed damper shown.
 - The blk/wh and gray/wh wires are removed when Aux Heat is installed
 - Use part number 19P592-01 (jumper bar assembly) when single source power is required.
 - Air Flow Configuration Example: SW1 configured for dip 1 as low, dip 3 as medium, and dip 5 as high speed ECM fan.
 - SW2.8 must be in the OFF position for pulsed 'L' lockout signal and in the ON position for constant 'L' lockout signal.
 - A hydronic input will generate a Y2 compressor call so that compressor only operates in high capacity.
 - Low voltage wiring CLASS 2.
 - On units with a Perfect Speed ECM blower motors, the blower's low voltage harness from the board with the P12 connector will connect to a jumper harness that is connected to the blower motor. SW3-3 DIP switch should be set in the OFF position.

Wiring Schematics cont.

208-230/60/1 ECM with IntelliStart

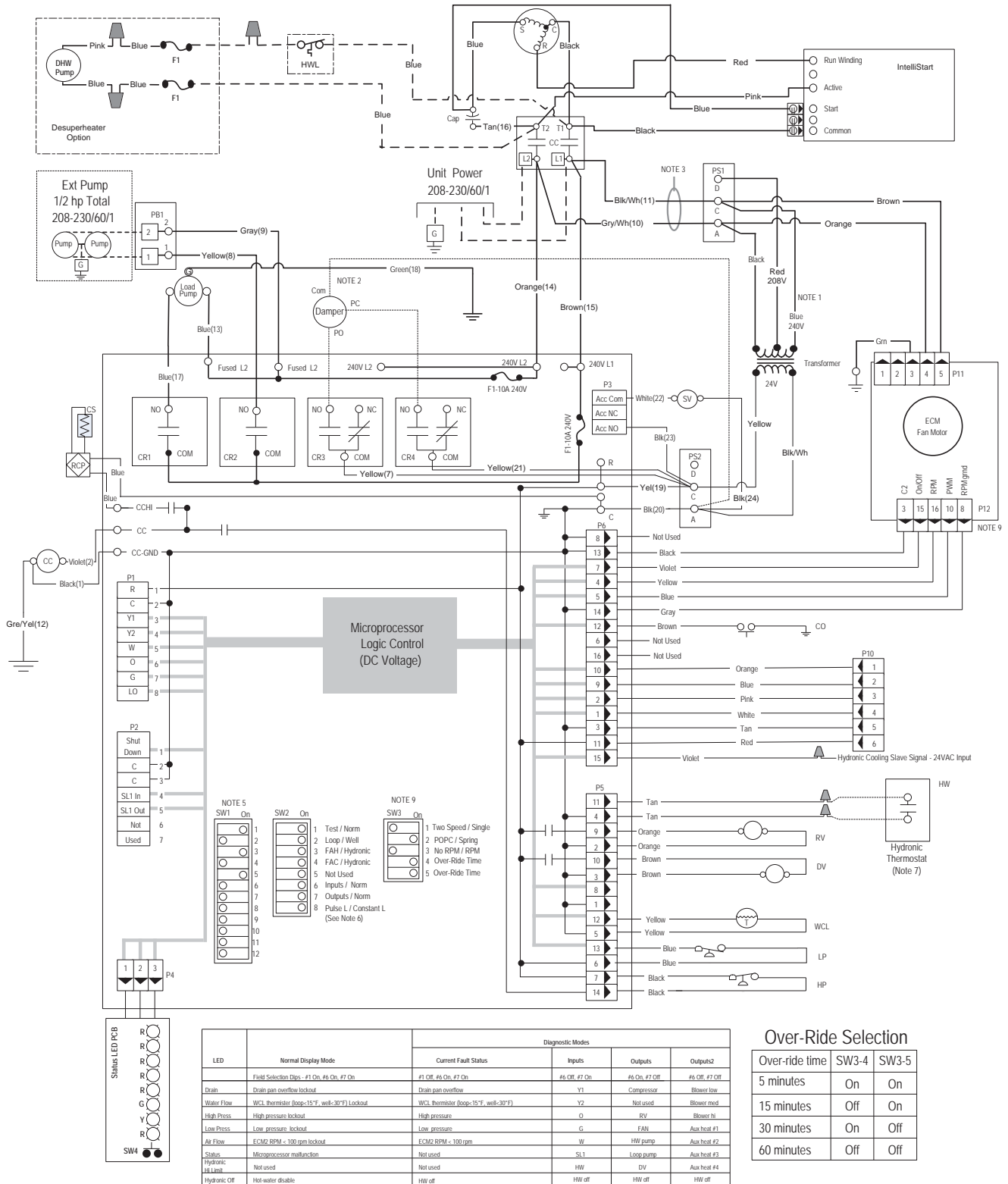

Wiring Schematics cont.

208-230/60/1 ECM with IntelliStart cont.

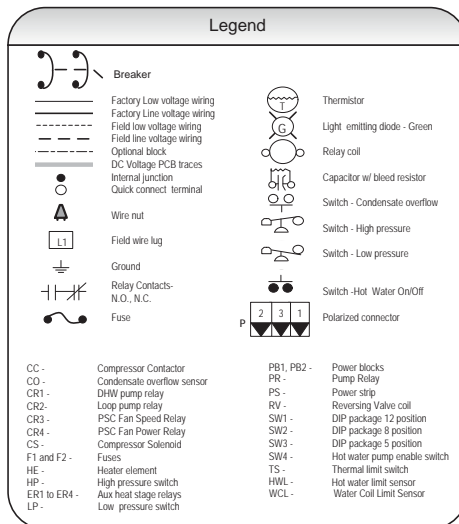
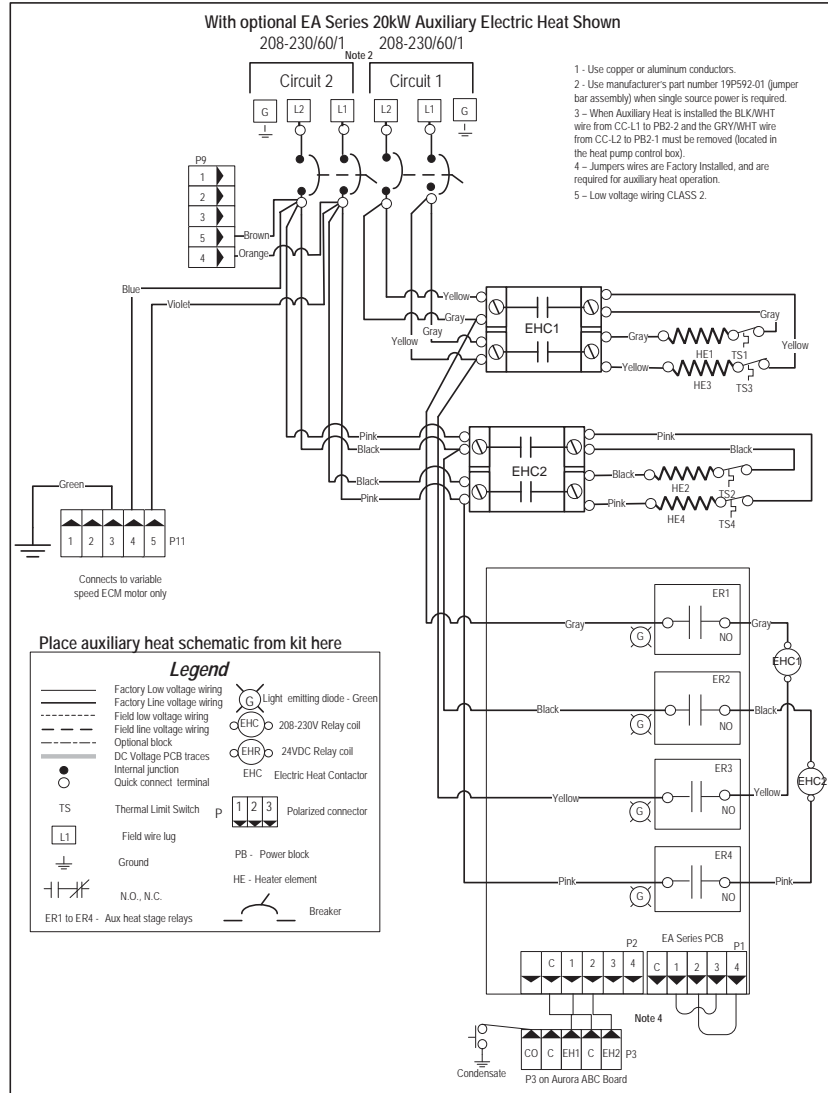
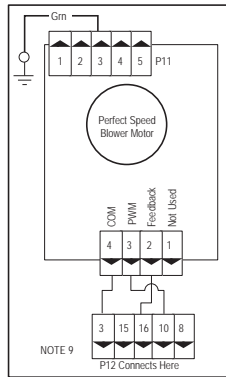

Operation Logic Data

Operation Logic Table	Heating				Cooling		Hot Water Mode
	STG1	STG2	STG3	EMERG	STG1	STG2	
Compressor	On	On	On	Off	On	On	Stg 2 On
Reversing Valve	Off	Off	Off	Off	On	On	Off
Loop Pump	On	On	On	Off	On	On	On
Load Pump	Off	Off	Off	Off	Off	Off	Off
Aux Heater	Off	Off	Staged	Staged	Off	Off	Off
Acc Relay	On	On	On	Off	On	On	Off
Diverting Valve	Off	Off	Off	Off	Off	Off	Off
ECM Speed	On	On	On	On	On	On	Off
T-Stat Signal	Y1	Y2	Y1, Y2, W	W	Y1, O	Y1, Y2, O	HW
Damper	Off	Off	Off	On	Off	Off	Off
Auxiliary 1 - Out	On	On	On	Off	On	On	On

- Notes**
- 1 - Switch blue and red wires for 208V operation.
 - 2 - Typical hook-up shown for power open - power closed damper shown.
 - 3 - The blk/wht and gray/wht wires are removed when Aux Heat is installed.
 - 4 - Use part number 19P592-01 (jumper bar assembly) when single source power is required.
 - 5 - Air Flow Configuration Example: SW1 configured for dip 1 as low, dip 3 as medium, and dip 5 as high speed ECM fan.
 - 6 - SW2-8 must be in the OFF position for pulsed "L" lockout signal and in the ON position for constant "L" lockout signal.
 - 7 - A hydronic input will generate a Y2 compressor call so that compressor only operates in high capacity.
 - 8 - Low voltage wiring CLASS 2.
 - 9 - On units with a Perfect Speed ECM blower motors, the blower's low voltage harness from the board with the P12 switch will connect to a jumper harness that is connected to the blower motor. SW3-3 DIP switch should be set in the OFF position.

Engineering Guide Specifications

General

Synergy3D units shall be floor mounted type with horizontal air inlet and vertical up flow or rear air discharge. Reverse cycle operation shall provide heating or cooling in the forced air mode. The unit shall also be capable of heating water for hydronic applications when the unit is not in the forced air mode. Units shall be AHRI/ISO Standard 13256-1 performance certified and listed by a nationally recognized safety-testing laboratory or agency, such as ETL Testing Laboratory. Each unit shall be computer run-tested at the factory. Each unit shall be mounted on a pallet for shipping.

The geothermal units shall be designed to operate with entering liquid temperature between 20°F and 120°F [-6.7°C - 48.9°C].

Refrigerant Circuit

All units shall contain a sealed refrigerant circuit including: a hermetic motor-compressor, discharge muffler, bidirectional thermal expansion valve, finned tube air-to-refrigerant heat exchanger, solenoid valve, diverting valve, check valve, reversing valve, source coaxial tube water-to-refrigerant heat exchanger, load coaxial tube refrigerant-to-water heat exchanger, optional hot water generator coil, and service ports.

Compressors shall be high efficiency dual capacity scroll type designed for heat pump duty and mounted on vibration isolators. Compressor motors shall be single-phase PSC with overload protection. The finned tube air-to-refrigerant heat exchanger will be aluminum tube/fin and shall be sized for low-face velocity and constructed of lanced aluminum fins bonded to performance enhanced tubes in a staggered pattern not less than three rows deep for superior performance. The aluminum tube and fin air-to-refrigerant heat exchanger has as optional to be electro-coated with AlumiSeal. All models shall include discharge line mufflers to help quiet compressor discharge gas pulsations.

All units shall have the source coaxial tube refrigerant-to-water heat exchanger and optional hot water generator ThermaShield coated.

Casing and Cabinet

The cabinet shall be fabricated from heavy-gauge galvanized steel and finished with corrosion-resistant powder coating. This corrosion protection system shall meet the stringent 1000 hour salt spray test per ASTM B117. The interior shall be insulated with 1/2-inch thick, multi-density, cleanable aluminum foil coated glass fiber with edges sealed or tucked under flanges to prevent

the introduction of glass fibers into the discharge air. Standard cabinet panel insulation must meet NFPA 90A requirements, air erosion and mold growth limits of UL-181, stringent fungal resistance test per ASTM-C1071 and ASTM G21, and shall meet zero level bacteria growth per ASTM G22. Unit insulation must meet these stringent requirements or unit(s) will not be accepted.

Two blower and three compressor compartment access panels shall be 'lift-out' removable with supply and return ductwork in place. The control box shall be hinged and removable to allow easy access to the compressor. The internal component layout shall provide for service access from the front side for restricted installations.

A duct collar shall be provided on the supply air opening. Standard size 2 in. [5.1 cm] MERV 11 pleated filters shall be provided with each unit. Vertical units shall have a return air filter rack/duct collar. The upflow vertical units shall have a removable insulated divider panel between the air handling section and the compressor section to minimize the transmission of compressor noise and to permit operational service testing without air bypass. Vertical units shall be supplied with left or right horizontal air inlet and top vertical or rear air discharge.

The compressor shall be double isolation mounted using selected durometer grommets to provide vibration free compressor mounting.

The drain pan shall be of plastic construction to inhibit corrosion and bacterial growth. Drain outlet shall be located on pan as to allow complete and unobstructed drainage of condensate. The unit as standard will be supplied with solid-state electronic condensate overflow protection. Mechanical float switches WILL NOT be accepted. Vertical units shall be furnished with a PVC slip condensate drain connection and an internal factory installed condensate trap.

Blower Motor and Assembly

The blower shall be a direct drive centrifugal type with a dynamically balanced wheel. The housing and wheel shall be designed for quiet low outlet velocity operation. Tight blower housing geometry shall not be permitted. The blower housing shall be removable from the unit without disconnecting the supply air ductwork for servicing of the blower motor. The blower motor shall be a variable speed ECM type. The variable speed ECM blower motor shall be soft starting, shall maintain constant CFM over its operating static range, and shall provide 12 CFM settings. The blower motor shall be isolated from the housing by rubber grommets. The motor shall be permanently lubricated and have thermal overload protection. Variable speed ECM motors shall be long-life ball bearing type.

Engineering Guide Specifications cont.

Electrical

A control box shall be located within the unit compressor compartment and shall contain a 75VA transformer, 24 volt activated, 2 pole compressor contactor, terminal block for thermostat wiring and solid-state controller for complete unit operation. Electromechanical operation WILL NOT be accepted. Units shall be name-plated for use with time delay fuses or HACR circuit breakers. Unit controls shall be 24 volt and provide heating or cooling as required by the remote thermostat/sensor. The controller shall also be capable of operating the unit in a hydronic heating mode with input from an external thermostat. A microprocessor-based controller that interfaces with a multi-stage electronic thermostat to monitor and control unit operation shall be provided. The control shall provide operational sequencing, blower speed control, blower failure, high and low pressure switch monitoring, freeze detection sensor temperature limit, condensate overflow sensing, auxiliary heat staging, lockout mode control, load pump and loop pump control, LED status and fault indicators, fault memory, field selectable options, and accessory output.

A detachable terminal block with screw terminals will be provided for field control wiring. All units shall have knockouts for entrance of low and line voltage wiring. The blower motor and control box shall be harness plug wired for easy removal.

Optional IntelliStart (Compressor Soft Starter) - shall be factory installed for use in applications that require low starting amps, reduced compressor startup noise, off-grid, and improved start-up behavior. IntelliStart shall reduce normal starting current by 60% on 208-230/60/1 units.

Piping

Source and load supply and return water connections shall be 1 in. [25.4 mm] FPT brass swivel fittings, which provide a union and eliminate the need for pipe wrenches and sealants when making field connections. The optional hot water generator shall have sweat type connections. All water piping shall be insulated to prevent condensation at low liquid temperatures. On the vertical upflow units, the condensate connection shall be a 3/4 in. [19.1 mm] PVC socket with internally-trapped hose that can be routed to front or side locations.

Options and Accessories

Cupronickel Heat Exchanger

An optional cupronickel water-to-refrigerant heat exchanger shall be provided.

Hot Water Generator

An optional ThermaShield coated heat reclaiming hot water generator coil of vented double-wall copper construction suitable for potable water shall be provided. The coil shall be factory mounted inside the unit. An internal pump is not included. Order DPK5 for field installed pump and temperature limit.

Thermostat (field-installed)

A multi-stage auto-changeover electronic digital thermostat shall be provided. The thermostat shall offer three heating and two cooling stages with precise temperature control. An OFF-HEAT-AUTO-COOL-EMERG system switch, OFF-AUTO blower switch, and indicating LEDs shall be provided. The thermostat shall display in °F or °C.

Electronic Air Cleaner (field-installed)

A 1 in. [25 mm] electronic air cleaner, cleanable 97% efficiency at 0.3 microns and larger, shall be provided in lieu of the standard throwaway filter. The initial pressure drop across the filter shall not exceed 0.2 in. w.g. at 300 fpm face velocity.

Electrostatic Air Cleaner (field-installed)

A 1 in. [25 mm] electrostatic air cleaner, cleanable 90% efficiency, shall be provided in lieu of the standard throwaway filter. The initial pressure drop across the filter shall not exceed 0.15 in. w.g. at 300 fpm face velocity.

AlpinePure 411-Rack 4 in. Pleated Filter Accessory

A 4 in. thick [102 mm] MERV 11 filter and filter rack shall be provided in lieu of the standard filter and rack.

AlpinePure MERV 13 Filter (field installed)

A 2 in. thick [50 mm] MERV 13 filter shall be provided in lieu of the standard filter and fits the factory filter rack. The filter maintains MERV 13 rating in full ASHRAE 52.2 independent testing as required for LEED® certification. Helps fulfill a full credit under the LEED® rating system.

Engineering Guide Specifications cont.

Earth Loop Flow Center (field-installed)

A self-contained module shall provide all liquid flow, fill and connection requirements for ground source closed loop systems up to 20 GPM. The pumps shall be wired to a power block located in the nearest unit. The heat pump units shall contain low voltage pump slaving control so that two units may share one flow center.

Auxiliary Heater (field-installed)

An electric resistance heater shall provide supplemental and/or emergency heating capability. Vertical units shall have the control box and resistance heater coil assembly mounted internally. A low voltage plug shall be provided in each unit for quick auxiliary heat connection. The heater shall operate in sequenced stages as controlled by the unit's microprocessor. The heater shall feed line voltage power to the unit blower and transformer to provide emergency heat capability in the event of an open compressor circuit breaker.

AlpinePure Drain Pan Treatment

Provides dependable, sustained time-release protection from slime build-up and foul smelling odors in the drain pan. Also adds a light, pleasant scent to the air.

Notes

Revision Guide

Pages:	Description:	Date:	By:
Misc.	Updated for Aluminum Coils, Wiring Schematics	15 May 2017	JM
42-45	Updated Wiring Schematic for Auxiliary Heat Changes, Updated ETL Logo	14 April 2015	MA
5	Updated Nomenclature Hot Water Generation Option	30 Sept 2014	MA
All	Updated to new Revision, Reformatted Layout	27 Dec 2013	DS
All	Updated Nomenclature to Reflect new ECM Blower Motor	09 Nov 2012	DS
All	Added Notes Regarding Discharge Muffler	11 Oct 2012	DS
28	Updated Cooling Capacity Corrections	11 Oct 2012	DS
All	Various Formatting Corrections	11 Oct 2012	DS
50	Added Revision Guide	11 Oct 2012	DS



Manufactured by
WaterFurnace International, Inc.
9000 Conservation Way
Fort Wayne, IN 46809
www.waterfurnace.com

